

MECCANO® **A** STARTER

BOOK OF MODELS

Voorbeeldenboek
Livre des modèles
Libro dei modelli
Modellbuch
Modellbok
Libro de modelos

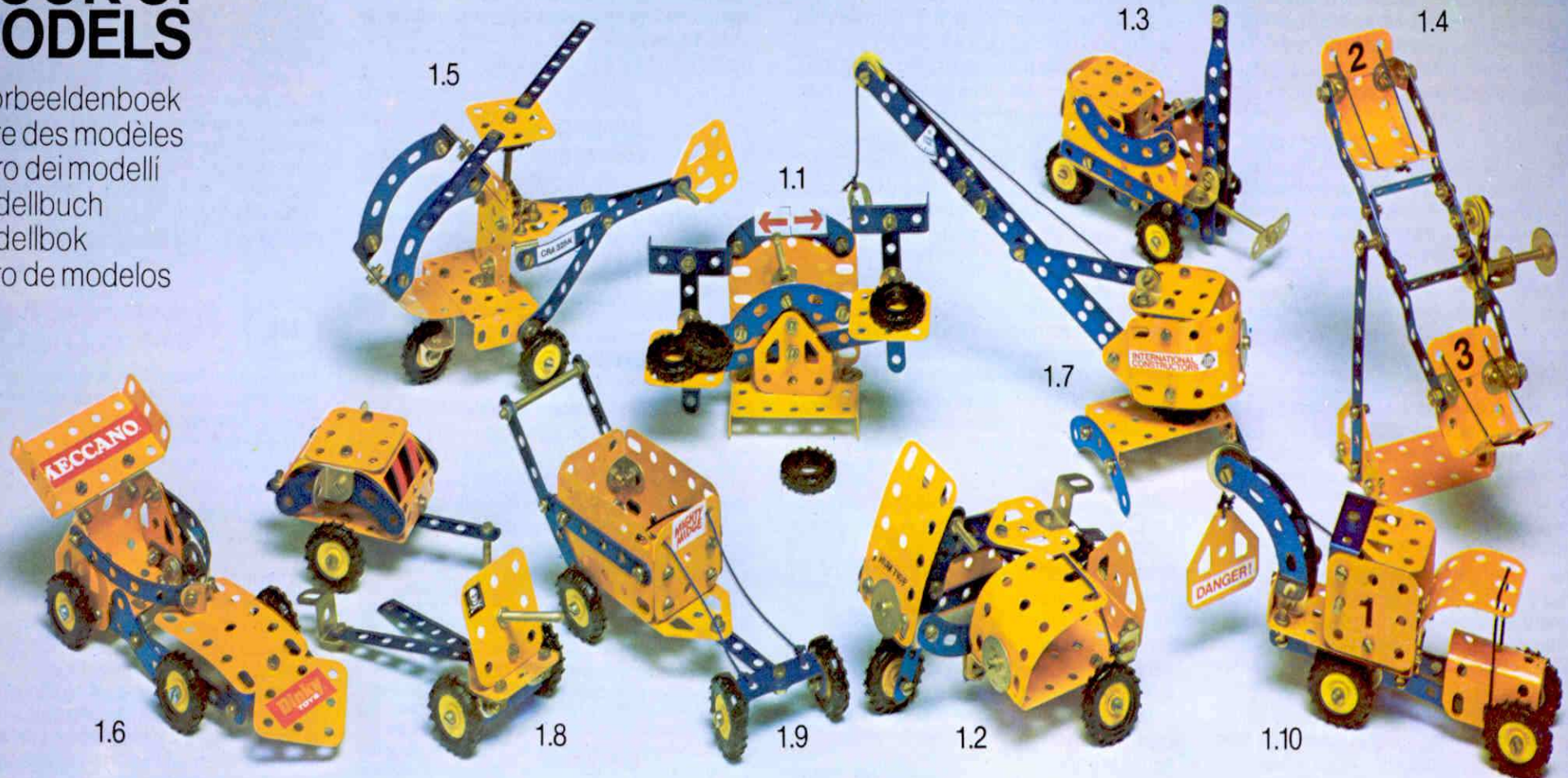

Welcome to the world of Meccano

GB

Now you have your own set of Meccano, you will find endless pleasure in constructing the models, in showing them to your friends, playing with them and even making some of them work for you.

In this manual there is a wide choice of different models to build, with detailed step by step instructions for most of them. But the *real* fun starts when you begin to design your own models. Use your imagination and skill to bring your ideas to life — with Meccano you can just build on, and on; the possibilities are endless.

The Meccano system has been designed so that you can build up your collection, to make bigger and more complex models. You can buy Extension Sets or separate parts: there are various motors, clockwork, electric, even steam; one day you could even own the highly coveted No. 10 Set.

F

Bienvenue au monde du Mécano

Maintenant que vous avez votre Mécano, vous trouverez un plaisir inouï dans la construction de modèles, dans la possibilité de les montrer à vos amis, de jouer et même de les faire opérer pour vous.

Dans ce manuel, vous trouverez un grand nombre de pièces à monter, et les instructions détaillées pour y arriver pas à pas pour la plupart d'entre elles. Mais la plus *grande* distraction commence lorsque vous créez vos propres modèles. Utilisez votre imagination et votre compétence pour faire naître vos idées — avec le Mécano vous pouvez continuer de construire sans arrêt, il n'existe aucune limite.

Le système du Mécano a été conçu de telle sorte que vous puissiez augmenter votre collection, pour fabriquer des modèles de plus en plus compliqués. Vous pouvez acheter des Jeux de Conversion ou des pièces séparées; il existe des moteurs variés, mécaniques,

électriques ou même à vapeur; un de ces jours vous pourriez même posséder le jeu légendaire No. 10.

N

Velkommen til Meccanos verden

Nå som du har fått ditt eget Meccano-sett vil du få stor glede av å bygge modeller, vise disse til dine venner og leke med dem og til og med få noen av disse til å arbeide for deg.

I denne boken finner du et stort utvalg av en hel rekke modeller som du kan bygge, med detaljerte anvisninger i de fleste tilfelle. Men den *virkelige* moro tar til når du begynner å lage dine egne modeller. Bruk din fantasi og dyktighet til å gjøre idéene dine om til praksis — med Meccano kan du bare fortsette å bygge videre og videre, mulighetene er endeløse.

Meccanosystemet er laget slik at du kan bygge opp din egen samling og lage større og mer innviklede modeller. Du kan kjøpe omdannings-sett eller individuelle deler, og det finnes forskjellige motorer, urverk, elektriske, til og med dampdrevne, og en dag vil du kanskje til og med eie det legendariske sett nr. 10.

D

Willkommen zur Welt des Meccano

Wenn Sie nun Ihren eigenen Meccanosatz besitzen, werden Sie fortdauerndes Vergnügen darin finden, Modelle zu konstruieren, sie Ihren Freunden zu zeigen, mit ihnen zu spielen und sogar einige von ihnen zum eigenen Nutzen zu gebrauchen.

In diesem Handbuch werden Sie eine grosse Auswahl verschiedener Dinge, die Sie bauen können, mit Schritt für Schritt-Beschreibung zur Konstruktion für die Mehrzahl, finden. Aber den grössten Spass macht es, wenn Sie anfangen, Ihre eigenen Modelle zu entwerfen. Lassen Sie Ihrer

Phantasie und Geschicklichkeit freien Lauf — mit Meccano können Sie bauen und bauen — die Möglichkeiten sind unbegrenzt.

Das Meccanosystem wurde so entworfen, dass Sie Ihre eigene Sammlung erweitern können, um grössere und schwierigere Modelle machen zu können. Sie können Zusammenlegungssätze oder getrennte Einzelteile kaufen; es gibt verschiedene Motoren, Uhrwerke, elektrisch, sogar Dampf; eines Tages könnten Sie sogar den berühmten Satz Nr. 10 besitzen.

E

Bienvenido al mundo del Meccano

Ya tienes tu propio juego de Meccano, encontraras un continuo placer construyendo los modelos, mostrandolos a tus amigos, jugando con ellos y aun más haciendolos funcionar.

En este manual encontrarás una gran variedad de cosas para construir, y está detallado paso a paso de como hacer la mayoría de ellos. Pero, la *verdadera* diversión comienza cuando empiezas a diseñar tus propios modelos. Usa tu imaginación y habilidades para poner tus ideas a la realidad — con un Meccano puedes inventar e inventar y las posibilidades son interminables.

El sistema del Meccano ha sido diseñado de tal manera que puedas aumentar tu colección para construir más grandes y más complicados modelos. Puedes comprar un equipo de transformación o partes separadas; hay varios motores, de cuerda, de electricidad y aún a vapor; y quizás algún día poseerás el legendario equipo No. 10.

I

Benvenuto al mondo del Meccano

Ora che tu hai la collezione tua propria del Meccano, proverai un infinito piacere a

costruire i modelli, a mostrarli ai tuoi amici, a giocare con loro, ed anche ad alcuni farli lavorare per te.

In questo manuale troverai una grande scelta di cose da costruire con le istruzioni dettagliate, passo passo, per il maggior numero di esse. Ma il *vero* divertimento inizia quando comincerai a disegnare i tuoi propri modelli. Usa la tua fantasia e abilità a rendere vive le tue idee — con il Meccano puoi appunto fare costruzioni su costruzioni, le possibilità sono infinite.

Il sistema del Meccano è stato disegnato di maniera che tu possa aumentare la tua collezione, fare modelli più grandi e più complicati. Puoi comprare collezioni diverse o pezzi separati; ci sono vari motori, a meccanismo dell'orologio, a elettricità, anche a vapore; un giorno tu potresti perfino possedere la collezione leggendaria No. 10.

NL

Welkom in de Meccano wereld

Je hebt nu je eigen Meccano set en je zal eindelijk plezier hebben, zelf modellen te maken, deze aan je vrienden te laten zien, ermee te spelen en zelfs voor je laten werken.

In deze handleiding vindt je een groot aantal verschillende dingen die je zelf kan bouwen, waarvoor duidelijke stap voor stap aanwijzingen worden gegeven. Maar het echte plezier begint pas wanneer je, je eigen modellen begint te ontwerpen. Gebruik je voorstellingsvermogen en bekwaamheid om je ideeën in het leven te roepen — met Meccano kan je steeds blijven doorbouwen, de mogelijkheden zijn eindeloos.

Het Meccano systeem is zo ontworpen dat je, je eigen collectie kan opbouwen om grotere en meer ingewikkelde modellen te kunnen maken. Je kan ombouwsets of afzonderlijke onderdelen kopen; verschillende motoren, uurwerk, elektrisch of zelfs stoom zijn verkrijgbaar; misschien zal je zelfs eens de legendarische no. 10 set bezitten.

GB

How to use this book

In this book the building instructions are mostly in the form of photographs showing step by step assembly of the models. Each model is assembled in sections and, at the start of each section, there is a photograph of the particular components used in that section. These photographs will help you identify the parts needed. You should first select the components from your set to avoid having to search for them during assembly. The sequence of assembly, i.e. progressing from one section to the next in correct order, should be followed as set out in the illustrations.

In most cases, the parts used in the models can be identified simply by looking at the illustrations, but where the identity of a part may not be clear, its part number is marked on the illustrations.

You will be able to identify these, and all the parts in the models, by studying the individual pictures of parts printed in this booklet.

Basic constructions

Some standard arrangements of parts are used repeatedly in Meccano model-building and these are called 'Basic Constructions' (BC's), and 'Basic Fixings' (BF's). They are illustrated in the following pages, and you will see that each is identified by a Code Mark, e.g. BC1, BC2, BF1, etc. When one of these Code Marks appears on the building illustrations, it indicates the Meccano Basic Construction to use.

F

Comment utiliser ce livret

Dans ce livret, les instructions d'assemblage sont pour la plupart données sous la forme de photographies pour la fabrication graduelle de modèles. Chaque modèle est assemblé en sections et, au début de chaque section, se trouve une photographie des pièces qui y sont utilisées. Ces photographies vous permettront d'identifier les pièces nécessaires. Vous devriez d'abord les sélectionner pour ne pas avoir à les chercher pendant l'assemblage. La séquence de l'assemblage, c.à.d. le passage d'une section à une autre dans le bon ordre, devrait être suivie d'après les illustrations.

Dans la plupart des cas, les pièces doivent être utilisées pour les modèles peuvent être identifiées simplement en se référant aux illustrations mais lorsque l'identification d'une pièce n'est pas claire, son numéro est donné sur l'illustration.

Vous pourrez les identifier et toutes les parties des modèles, en examinant les illustrations séparées des pièces se trouvant dans ce livret.

Constructions de base

Des sélections standards de pièces sont fréquemment utilisées dans la construction de modèles de Mécano et elles sont appelées 'Constructions de Base' (BC's), et 'Fixations de Base' (BF's). Elles sont illustrées sur les pages qui suivent et vous verrez que chacune d'elle est identifiée

par un numéro de code, c.à.d. BC1, BC2, BF1, etc. Lorsqu'un numéro de code est donné sur l'illustration d'assemblage, il indique la Construction de Base Mécano à utiliser.

N

Slik bruker du denne vesle boken

De fleste byggeanvisningene er i form av fotografier som viser deg hvorledes du bygger modellene, trinn for trinn. Hver modell settes sammen i seksjoner og ved begynnelsen av hver seksjon finnes det et fotografi av de delene som danner den seksjonen. Disse fotografiene vil hjelpe deg til å identifisere de deler du trenger. Ta delene du trenger opp av esken før du begynner å bygge, da går byggingen lettere unna. Se godt på illustrasjonene og følg byggekkefølgen, dvs. den gradvise utvikling fra en seksjon til den neste i riktig rekkefølge.

I de fleste tilfelle kan de deler du bruker i modellene lett gjenkjennes bar ved å se på illustrasjonene, men hvor identiteten av en del ikke er helt klar står delnummeret merket av på illustrasjonene.

Du blir i stand til å identifisere disse og alle delene i modellene ved å se på de individuelle bildene av delene som står i denne vesle boken.

Grunnmodeller

En del standardarrangement av deler går igjen i modellbygging med Meccano, og disse kalles grunnmodeller (BC) og grunn typer (BF). Disse står avbildet på de følgende sidene og du vil se at hver av disse har et kodemerke, f.eks. BC1, BC2, BF1 osv. Når ett av disse kodemerkene står i byggeanvisningene viser det til den Meccano grunnmodellen du skal bruke.

D

Wie dieses Handbuch zu benutzen ist

In diesem Büchlein werden die Bauinstruktionen meistens als Fotos, welche die Zusammenstellung der Modelle Schritt für Schritt zeigen, gegeben. Jedes Modell wird aus Teilabschnitten zusammengesetzt und am Anfang jedes Teilabschnitts ist ein Foto von den besonderen Bestandteilen, die in diesem Teil gebraucht werden. Diese Fotos helfen Ihnen, die benötigten Stücke zu identifizieren. Sie sollten am Anfang zuerst die Bestandteile Ihres Satzes herausuchen, um eine Suche während der Zusammensetzung auszuschalten. Die Folge der Zusammensetzung, z.B. die Aufeinanderfolge von einem Teilabschnitt zum Nächsten in genauer Reihenfolge, sollte nach den gegebenen Illustrationen ausgeführt werden. In den meisten Fällen können die Teile, die in den Modellen gebraucht werden, einfach durch Besichtigung der Illustrationen identifiziert werden, aber sollte die Identität eines Teiles nicht ganz klar sein, ist die Kennnummer des Teiles auf der Illustration angegeben.

Sie können diese und alle Teile der Modelle identifizieren, wenn Sie die einzelnen Zeichnungen der Teile, die in diesem Büchlein gedruckt sind, genau betrachten.

Grundkonstruktionen

Einige Standardzusammenstellungen von Teilen werden wiederholt im Meccanomodellbau benutzt und diese werden "Basic Constructions" (BC's) (Grundkonstruktionen), und "Basic Fixings" (BF's) (Grundzubehör), genannt. Sie sind auf den folgenden Seiten illustriert und Sie werden sehen, daß jede durch eine Codebezeichnung gekennzeichnet ist, z.B. BC 1, BC 2, BF 1 u.s.w. Wenn eine dieser Codebezeichnungen bei den Bauillustrationen auftritt, weist sie auf die zu benutzende "Basic Construction" (Grundkonstruktion) hin.

E

Como usar este folleto

En este folleto las instrucciones están principalmente en figuras mostrando paso a paso el ensamblamiento de los modelos. Cada modelo está ensamblado en secciones, y al comienzo de cada sección hay figuras de las piezas que se necesitan en esa sección.

Estas figuras te ayudarán a identificar las partes que necesitas. Primero, deberás seleccionar las partes de tu equipo que necesitas, para evitar tener que buscarlas cuando estás ensamblando. La secuencia de ensamblamiento, que es: avanzar de una sección a otra en el orden correcto, debe seguirse como se indica en las ilustraciones.

En la mayoría de los casos, las partes que se necesitan en los modelos pueden ser identificadas mirando las ilustraciones, pero si alguna parte no está muy clara el número correspondiente a dicha pieza está marcado en las ilustraciones.

Será posible que identifiques las piezas, y todas las partes de los modelos estudiando individualmente las figuras de las partes impresas en este folleto.

Construcciones basicas

Algunas uniones de piezas son estandar y se usan repetidamente en el Meccano. Estas se llaman "Construcciones Básicas" (BC's), y "Uniones Básicas" (BF's). En las ilustraciones de las siguientes páginas podrás ver que cada una está identificada por claves, por ejemplo BC1, BC2, BF1, etc. Cuando una de estas claves aparece en la ilustración de lo que vas a formar te está indicando la Construcción Básica del Meccano que debes usar.

I

Come usare quest'opuscolo

In quest'opuscolo le illustrazioni di costruzione sono per lo più nella forma di fotografie che mostrano, passo passo, l'assemblaggio dei modelli. Ogni modello è montato a sezione e, all'inizio di ogni sezione, c'è una fotografia dei precisi componenti usati in quella sezione. Queste fotografie ti aiuteranno a riconoscere le parti che occorrono. Tu dovresti prima selezionare i pezzi della tua collezione per evitare di cercarli quando li assembli. La successione dell'assemblaggio, cioè, proseguendo da una sezione

all'altra nell'ordine corretto, dovrebbe essere imitata come mostrata sulle illustrazioni.

In molti casi, le parti usate nei modelli si possono riconoscere guardando semplicemente le illustrazioni, ma dove l'identità di una parte potrebbe essere non chiara, il numero della sua parte è segnato sulle illustrazioni. Potrai distinguere queste e tutte le parti dei modelli, studiando i quadri singoli delle parti stampate in quest'opuscolo.

Costruzioni base

Degli assestamenti normali delle parti si usano ripetutamente nella costruzione — modello del Meccano, e questi sono chiamati "Costruzioni Base" (BC's), e "Fissaggio Base" (BF's). Essi sono illustrati nelle seguenti pagine, e tu vedrai che ognuno è identificato dai segni del codice, per esempio: BC1, BC2, BF1, ecc. Quando uno di questi segni del codice è mostrato sulle illustrazioni di costruzione, indica di usare la Costruzione Base del Meccano.

NL

Hoe dit boekje te gebruiken

In dit boekje zijn de bouwaanwijzingen meestal in de vorm van foto's aangegeven, die stap voor stap de montage van de modellen illustreren. Elk model wordt uit secties samengesteld, aan het begin van elke sectie is er een foto van de bepaalde onderdelen die voor die sectie nodig zijn. Met behulp van deze foto's kunnen de benodigde onderdelen worden herkend. Je moet eerst de onderdelen uit je set uitkiezen, om te voorkomen dat ze gedurende montage moeten worden uitgezocht. De montage volgorde, d.w.z. de vooruitgang van een sectie naar de volgende in de juiste volgorde, moet volgens de afbeeldingen geschieden.

De onderdelen die voor de modellen moeten worden gebruikt kunnen meestal worden herkend door eenvoudig de afbeeldingen te bekijken, maar waar het type onderdeel niet duidelijk is, is het onderdeelnummer op de afbeelding aangegeven.

Je kan deze herkennen en ook alle andere onderdelen in de modellen door de afzonderlijke afbeeldingen van onderdelen te bestuderen die in dit boekje zijn opgenomen.

Fundamentele aanwijzingen

In Meccano modelbouw worden herhaaldelijk een aantal standaard onderdeelsamenstellingen toegepast die "basisconstructies" (B.C.'s) en "basisbevestigingen" (B.B.'s) worden genoemd. Ze zijn op de volgende pagina's afgebeeld en je zal merken dat elk dezer met een codemerk is gemerkt b.v. BC1, BC2, BB1 enz. Wanneer een dezer codemerk in de bouwafbeeldingen voorkomt, geeft het aan welke Meccano basisconstructie moet worden gebruikt.

GB



BC1 This joins two strips together so that they can move. It's one kind of locknut. You push a bolt through the strips, thread one nut onto the bolt (but don't tighten it so much that the strips can't move), thread on the second nut and tighten it against the first, using the two spanners provided.



BC2 This is another kind of locknut. Push the bolt through one of the strips and thread on the first nut. Then push the second strip over the end of the bolt and thread on the second nut. Tighten the nuts against both sides of the second strip so that the first strip moves freely on the bolt.

BC4 This is a way of joining two strips together.

BC15 This is a collar used to form a bearing or a support for an axle. The bolt must not obstruct the centre hole carrying the axle and the nut should be locked against the supporting plate or strip.

Nuts and bolts can be used in different ways for different jobs. These 'bolt fixtures' have been numbered BF1, BF2 etc., so that you can recognise them in the photographs. When longer bolts are required you will see that their sizes have been indicated.

You will also see these symbols   and .

The first,  indicates that the parts concerned will move freely. The second, , shows that these parts will also move, but that there will be some resistance to totally free movement, allowing the parts to stay in any position you want. The last symbol, , indicates the points where the cord should be tied.

Finally, you will see a number of 'W's' marked on the photographs. These show where washers are required. W x 2 means that you should use two washers, W x 3 means three washers, and so on.

F

BC1 Ceci permet de joindre deux pièces de façon qu'elles restent mobiles. C'est une sorte de contre-écrou. Glissez un boulon dans



les pièces, vissez un écrou au boulon (mais sans serrer pour ne pas bloquer les pièces), visser le deuxième boulon et bloquez-le contre le premier en utilisant les deux clés fournies.



BC2 C'est un autre type de contre-écrou. Glissez le boulon dans l'une des pièces et vissez sur le premier écrou. Puis glissez la deuxième pièce sur l'extrémité du boulon et vissez le deuxième écrou. Serrez les écrous des deux côtés de la seconde pièce de façon que la première puisse tourner autour du boulon.

BC4 C'est une façon d'assembler deux pièces.

BC15 Ceci est un collier qui sert de palier ou de support à un arbre. Le boulon ne doit bloquer le trou central qui supporte l'arbre, et l'écrou doit être serré contre la plaque ou pièce de support.

Il y a plusieurs façons de se servir des boulons et écrous selon le résultat que l'on veut obtenir. Ces divers "montages de boulons" ont été numérotés BF1, BF2... de façon que vous puissiez les identifier facilement sur les photographies. Lorsque vous avez besoin de boulons plus longs, il faut vous reporter à leur numéro de pièce qui indique celui qui convient.

Vous remarquerez également les symboles   et .

Le premier, , indique que les pièces en question doivent rester mobiles. Le deuxième, , signifie que ces pièces doivent aussi rester mobiles, mais rencontrer quand-même une certaine résistance qui les empêchent de bouger librement, de façon qu'elles restent dans la position où vous voulez les mettre. Le dernier symbole, , indique les points où il faut attacher le cordon.

Enfin, vous remarquerez également un certain nombre de W sur les photographies. Ils indiquent les endroits où il faudra placer une rondelle. W x 2 signifie que vous devez mettre deux rondelles, W x 3 trois rondelles etc...

N

BC1 Denne forbinder to deler slik at de kan bevege seg. Det er en slags låsemutter. Du skyver en skrue gjennom delene, trer den ene mutteren inn på skruen (men trekk ikke så



meget til at delene ikke kan bevege seg fritt), tre så den andre mutteren på og trekk denne til mot den første ved hjelp av de to skrunøkene.



BC2 Dette er en annen slags låsemutter. Skyv skruen gjennom en av delene og sett den første mutteren på skruen. Skyv så del nr. to inn over enden av skruen og sett den andre mutteren på. Trekk så mutrene til mot begge sider av denne siste delen slik at den første delen beveger seg fritt om skruen.

BC4 Dette er en måte å skjote to deler sammen på.

BC15 Dette er en krave som brukes til å danne et lager eller en støtte for en aksel. Skruen må ikke på noen måte stoppe til senterhullet som akselen løper gjennom, og mutteren må trekkes godt til mot støtteplaten eller delen.

Muttre og skruer kan brukes på forskjellige måter etter behov. Disse "skruerfestene" er blitt nummerert BF1, BF2 osv., slik at du kan kjenne dem igjen på fotografier. Hvor det er påkrevd med lange skruer vil du se at delnumrene angir de skruene du skal bruke.

Du vil også se disse tegnene   og .

Det første, , betyr at den delen det dreier seg om vil bevege seg fritt. Det andre tegnet, , viser at disse delene vil også bevege seg, men at der vil være en viss motstand slik at delene kan holde seg i en hvilken som helst stilling du ønsker. Det siste tegnet, , angir de punktene hvor tråden skal knyttes.

Endelig vil du se en del "W" merket av på fotografiene. Disse viser hvor du trenger skiver (pakninger). W x 2 betyr at du må bruke to slike skiver, W x 3 betyr tre skiver osv.

D

BC1 Hierbei werden zwei Streifen zusammengefügt, so daß sie sich bewegen können, also eine Art Knebelgriff. Du steckst eine Schraube durch die Streifen und drehst eine Mutter auf die Schraube (aber nicht so stark anziehen, daß sich die Streifen nicht bewegen können). Dann drehst Du eine zweite Mutter und ziehst sie gegen die erste an, wozu Du die beiden beigefügten



Schraubenschlüssel verwendest.



BC2 Hierbei handelt es sich um einen anderen Knebelgriff. Du steckst die Schraube durch einen der Streifen und drehst die erste Mutter auf. Dann setzt Du den zweiten Streifen auf das Ende der Schraube und drehst die zweite Mutter auf. Die Muttern werden an beiden Seiten des zweiten Streifens festgezogen, so daß sich der erste Streifen frei um die Schraube bewegen kann.

BC4 Hierbei handelt es sich um eine Verbindung von zwei Streifen.

BC15 Hierbei handelt es sich um eine Manschette, die ein Lager oder eine Auflage für eine Achse bildet. Die Schraube darf das Mittelloch, das die Achse aufnimmt, nicht behindern, und die Mutter ist fest am Halteblech oder Streifen anzuziehen.

Schrauben und Muttern können für verschiedene Arbeiten verschieden eingesetzt werden. Diese "Verschraubungen" wurden mit BF1, BF2, usw. bezeichnet, so daß Du sie auf den Fotos erkennen kannst. Wenn längere Schrauben erforderlich sind, werden die Teilenummern angegeben, so daß Du genau weißt, welches zu benutzen ist.

Du findest ferner die Symbole   und .

Das erste Symbol, , gibt an, daß sich die entsprechenden Teile frei bewegen. Das zweite, , gibt an, daß sich diese Teile ebenfalls bewegen, daß jedoch ein gewisser Widerstand bei der völlig freien Bewegung besteht, so daß die Teile in der Position bleiben, die Du wünschst. Das letzte Symbol, , gibt die Stellen an, wo die Kordel anzuknüpfen ist.

Schließlich siehst Du auf den Fotos mehrere "W". Diese bedeuten, daß Unterlegscheiben erforderlich sind. W x 2 bedeutet, daß Du zwei Unterlegscheiben benutzen mußt, W x 3 bedeutet 3 Unterlegscheiben usw.

E

BC1 Esta pieza es una especie de contratuerca que permite unir dos tiras de manera que puedan moverse. A través de las tiras se introduce un tornillo y se le enrosca



una tuerca (pero sin apretarla hasta tal punto que no puedan moverse las tiras); enrosque la segunda tuerca y apriétela contra la primera, empleando las dos llaves incluidas en el suministro.



BC2 Esta es otra clase de contratuerca. Introduzca el tornillo por una de las tiras y enrósquele la primera tuerca. A continuación, introduzca la segunda tira sobre el extremo del tornillo y enrosque la segunda tuerca. Apriete las tuercas contra los dos lados de la segunda tira de modo que la primera pueda moverse libremente sobre el tornillo.

BC4 Esta pieza se emplea para unir dos tiras.

BC15 Este es un collarín que se emplea para formar un cojinete o soporte para un eje. El tornillo no debe obstruir el agujero central en el que va introducido el eje, y la tuerca se debe apretar sólidamente contra la tira o placa de apoyo.

Las tuercas y tornillos se pueden utilizar en distintos modos para distintas operaciones. A estos 'dispositivos de sujeción' se les han dado los números BF1, BF2, etc., para que puedan identificarse en las fotografías. Si se necesitan tornillos más largos, basta consultar los números de pieza para determinar el tipo correcto a emplear.

También se verán los símbolos   y .

El primero,  indica que las piezas a que se refiere podrán moverse libremente. El segundo,  indica que estas piezas también se moverán, pero con cierta restricción del movimiento libre, lo que permite que las piezas permanezcan en el lugar que se desee. El último símbolo,  indica los puntos en que debe atarse la cuerda.

Por último, observará que en varias partes de las fotografías aparece la letra 'W'. Esta indica los puntos en que se necesitan arandelas. W x 2 significa que se deben emplear dos arandelas, W x 3 significa tres arandelas, etc.

NL



BC1 Dit verbindt twee strips aan elkaar zodat ze kunnen bewegen. Het is een soort borgmoer. Je duwt een bout door de strips, zet een moer op de bout (maar niet te vast aandraaien zodat de strips niet kunnen bewegen), zet een tweede moer op en draai deze vast tegen de eerste aan, gebruik de twee verstrekte moersleutels.

BC2 Dit is een ander soort borgmoer. Duw de bout door een van de strips en zet de eerste moer op. Duw dan de tweede strip over het einde van de bout en zet de tweede moer op. De moeren aan beide kanten van de tweede strip aandraaien zodat de eerste strip zich vrij op de bout kan bewegen.

BC4 Dit is een manier op twee strips aan elkaar te verbinden.

BC15 Dit is een kraag voor het vormen van een lager of ondersteuning voor een as. De bout mag niet het middengat versperren waar de as doorheen loopt en de moer moet tegen de steunplaat of strip vastgedraaid worden.

Moeren en bouten kunnen op diverse manieren voor verschillende werkjes gebruikt worden. Deze 'boutonderdelen' zijn genummerd BF1, BF2, enz., zodat je ze in de foto's kunt herkennen. Als er langere bouten nodig zijn, kun je hun onderdeelnummers zien die aangeven welke je moet gebruiken.

Je zult ook de symbolen   en  zien.

De eerste  duidt aan dat de betreffende delen vrij bewegen. De tweede  toont aan dat deze delen wel bewegen, maar dat er enige weerstand is tegen een volkomen vrije beweging, waardoor de delen in iedere willekeurige stand blijven die je wenst. Het laatste symbool  geeft aan de diverse punten waar het koord geknoopt moet worden.

En tenslotte zie je ook nog een aantal 'W' en op de foto's. Deze duiden aan waar onderlegplaatjes nodig zijn. W x 2 betekent dat je twee onderlegplaatjes moet gebruiken, W x 3 betekent drie onderlegplaatjes, enz.

I







BC1 Con questo giunto si uniscono due strisce in modo da consentirne il movimento. È un tipo di giunto a controdado. Si inserisce un bullone attraverso le strisce, si avvista un dado sul bullone (ma senza stringerlo eccessivamente, per non impedire il movimento delle strisce), si avvista il secondo dado e lo si serra contro il primo, usando le due chiavi fornite con la scatola.

BC2 Anche questo è un giunto a controdado. Inserire il bullone attraverso una delle strisce, e avvitare il primo dado. Inserire quindi la seconda striscia sull'estremità del bullone e avvitare il secondo dado. Serrare i dadi contro entrambi i lati della seconda striscia, in maniera che la prima striscia si muova liberamente sul bullone.

BC4 Questo è un metodo per unire insieme due strisce.

BC15 Questo è un collarino usato per formare un cuscinetto o supporto per un asse. Il bullone non dovrà ostruire il foro centrale di supporto dell'asse, ed il dado dovrà essere bloccato contro la piastra o striscia di supporto.

I dadi ed i bulloni possono venire usati in varie maniere per diverse funzioni. Questi 'fissaggi a bullone' sono stati numerati BF1, BF2, ecc., in maniera da poterli identificare facilmente nelle fotografie. Quando occorre usare dei bulloni più lunghi, potrete individuare il loro numero di pezzo per usare il bullone addatto.

Noterete anche questi simboli:   e . Il primo,  significa che le parti indicate si muovono liberamente. Il secondo,  indica che anche queste parti si muovono, ma che vi sarà una certa resistenza contro il movimento completamente libero, consentendo in tal modo che le parti stesse rimangano in una qualsiasi posizione desiderata. L'ultimo simbolo,  indica i punti in cui si dovrà legare il cordoncino.

Infine, sulle fotografie vedrete marcata una serie di 'W'. Questi contrassegni indicano dove occorre montare delle rondelle. Il segno W x 2 significa che si devono usare due rondelle, W x 3 significa tre rondelle, e così via.

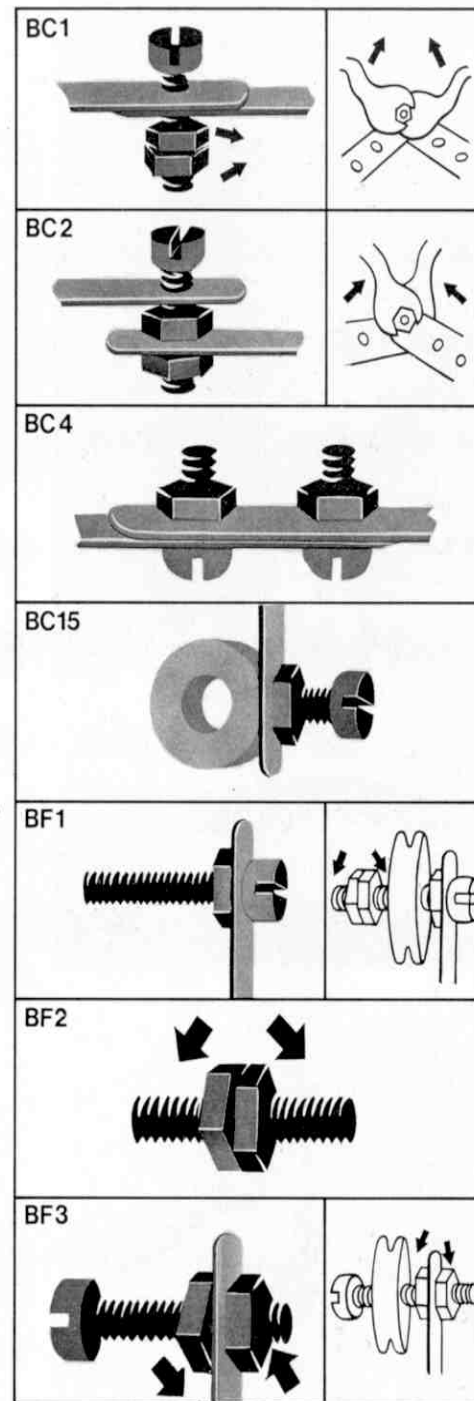

Scales

Balance
weegschaal
Waage
Vekt
Balanza
Bilancia

1.1

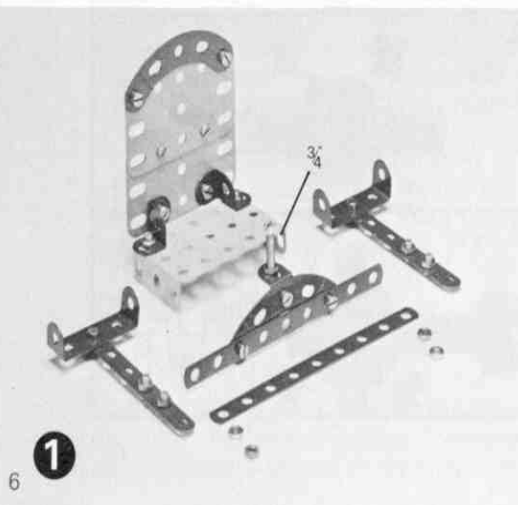
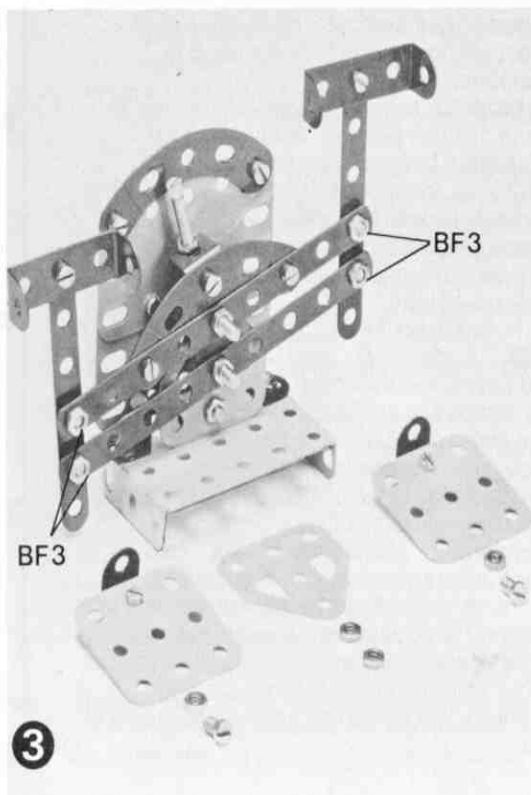
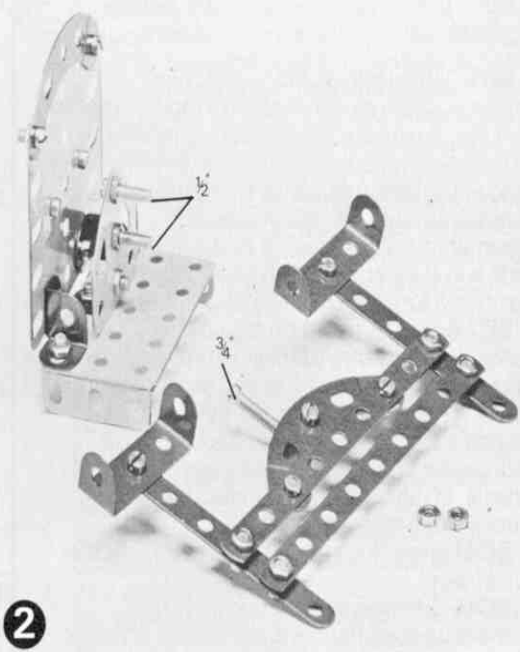

Motor Bike and Sidecar

Motocyclette et Sidecar
motorfiets met zijspan
Motorradgespann
Motorsykel med Sidevogn
Motocicleta con Sidecar
Motocarrozetta

1.2

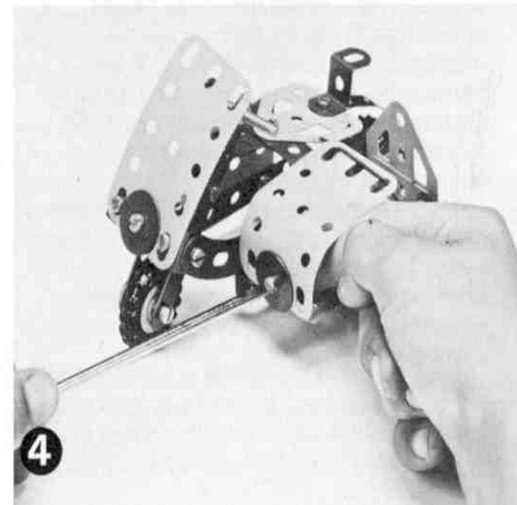
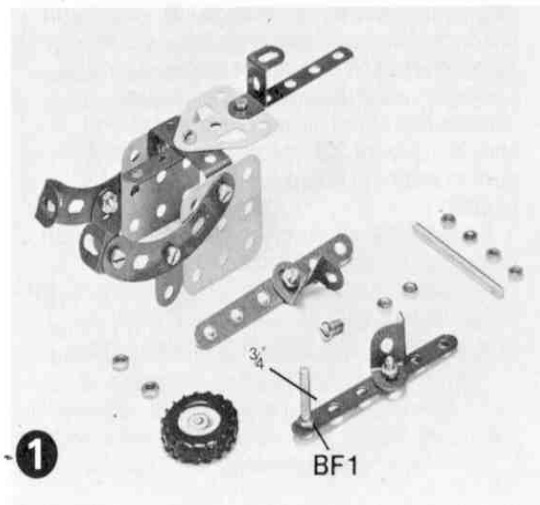
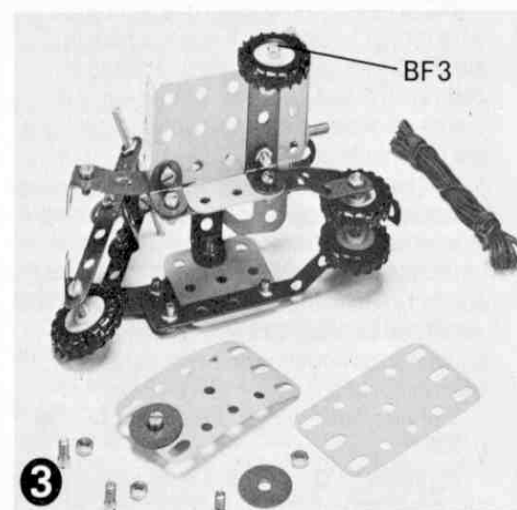
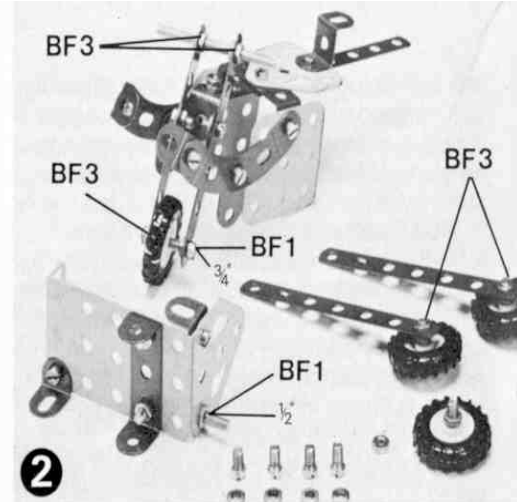
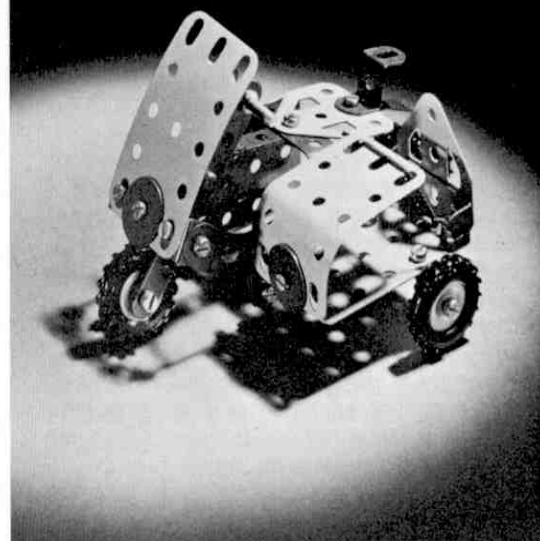

Forklift Truck

1.3

Camion elevateur
vorkhef-truck
Gabelstapler
Gaffeltruck
Carretilla elevadora
Carrello elevatore a forca

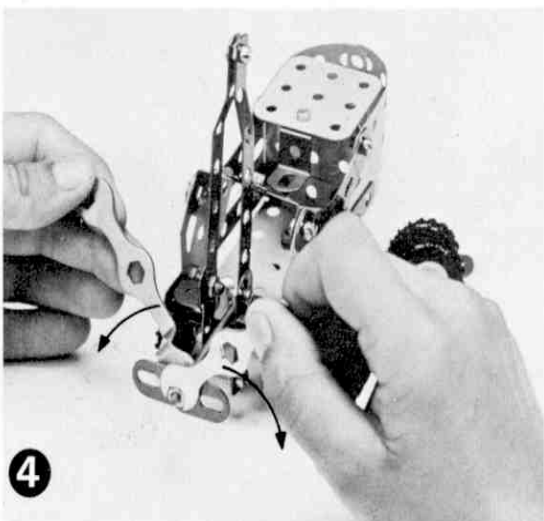
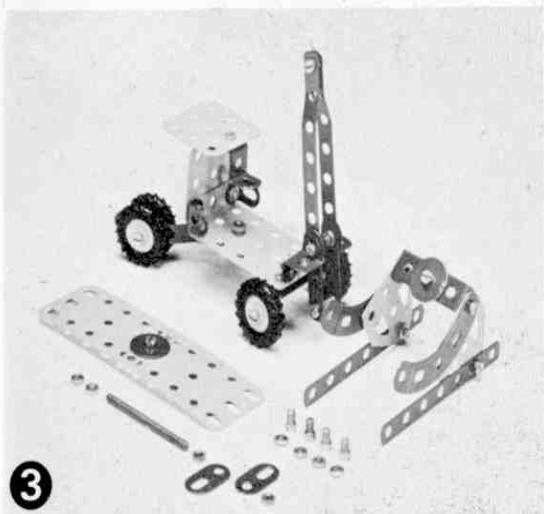
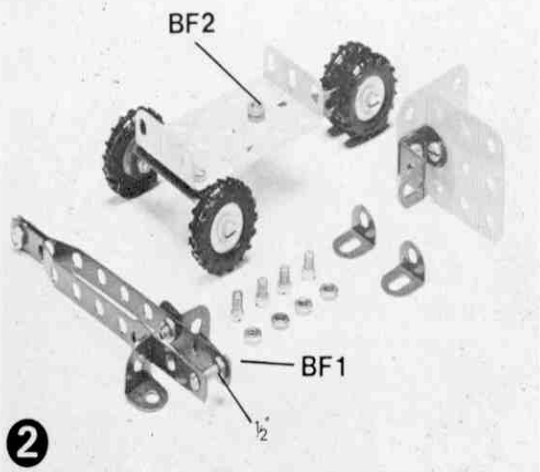

Ferris Wheel

1.4

Grande Roue
zweefrad
Riesenrad
Pariserhjul
Rueda Chicago
Giostra a ruota

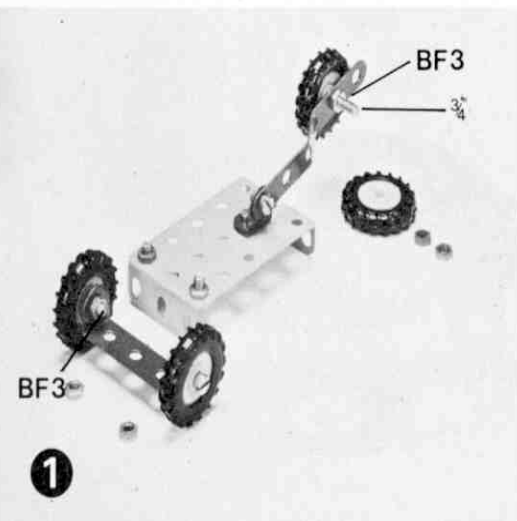
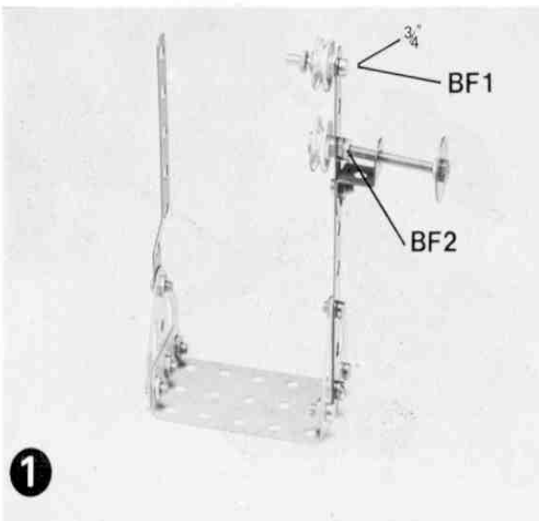
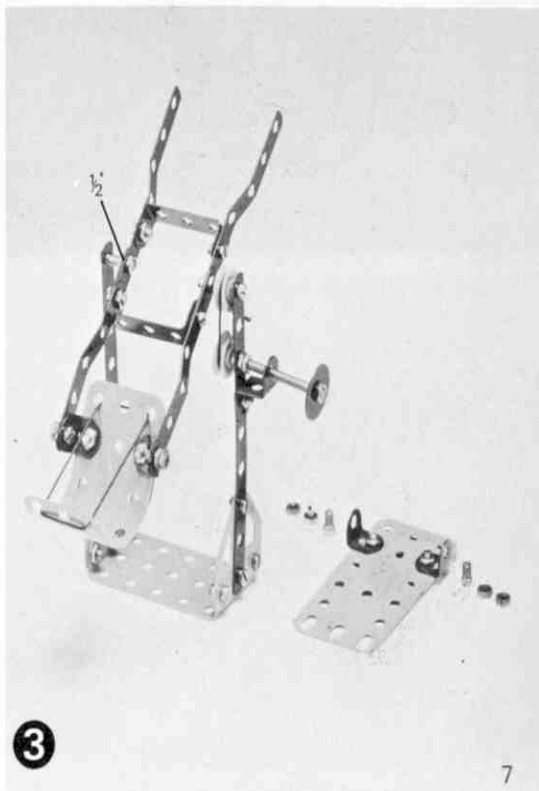
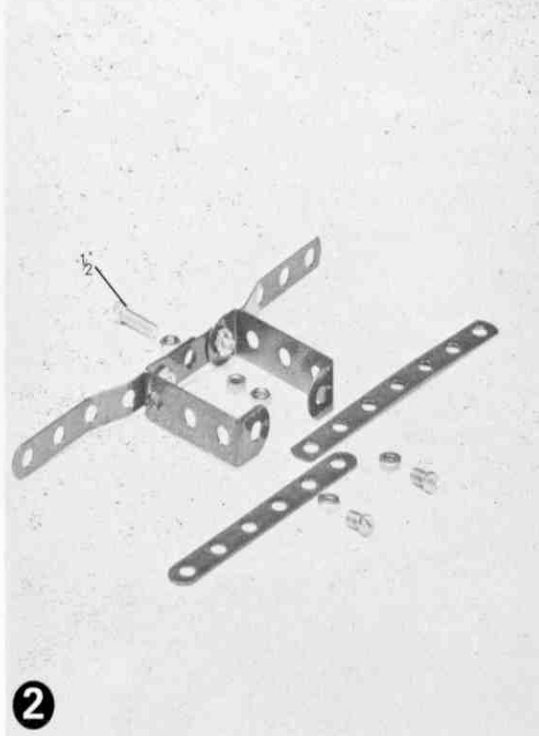
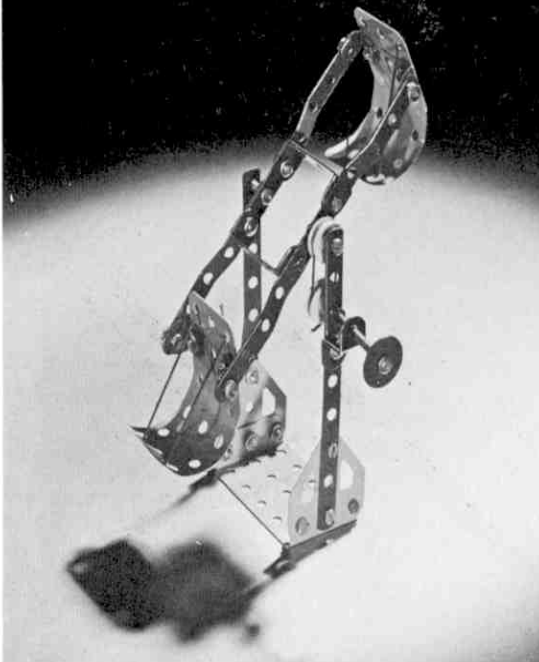

Helicopter

1.5

Helicoptere
hefschroefvliegtuig
Hubschrauber
Helikopter
Helicóptero
Élicottero

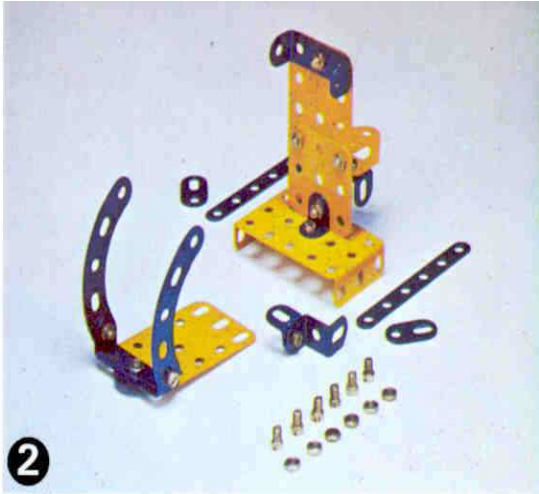

2

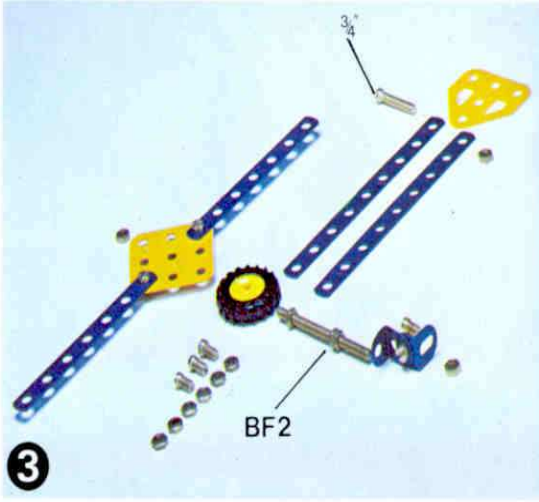

3

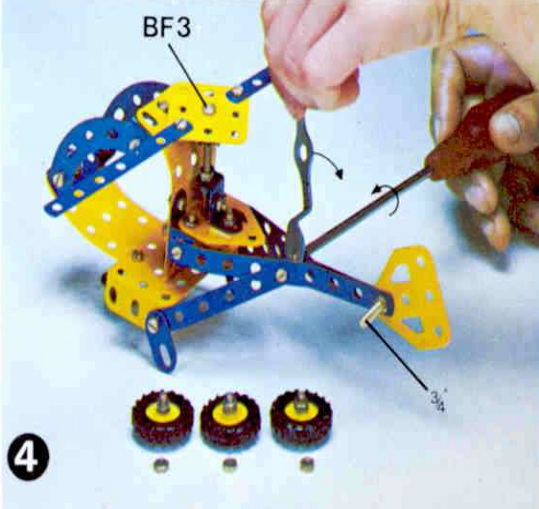

4

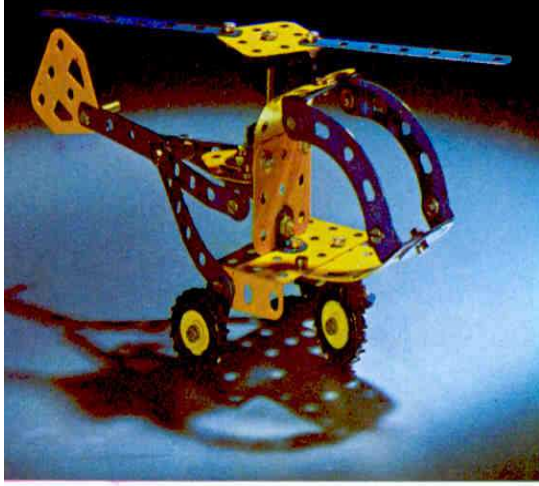

Racing Car

1.6

Voiture de course
race auto
Rennwagen
Racerbil
Carro de Carrera
Automobile de corsa



1

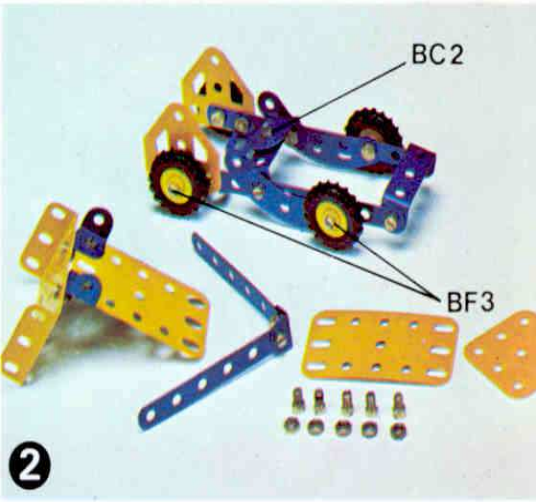

2

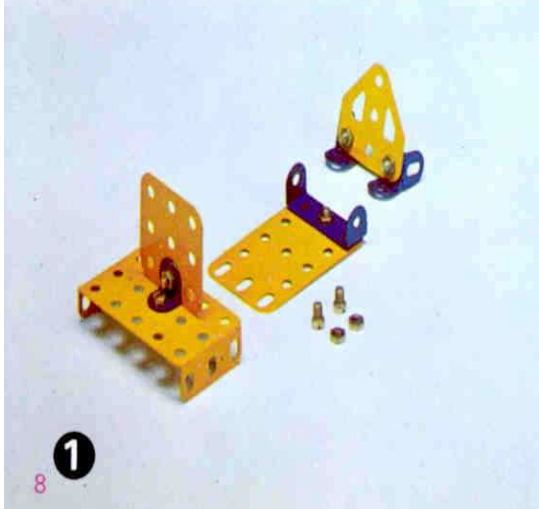

1



4

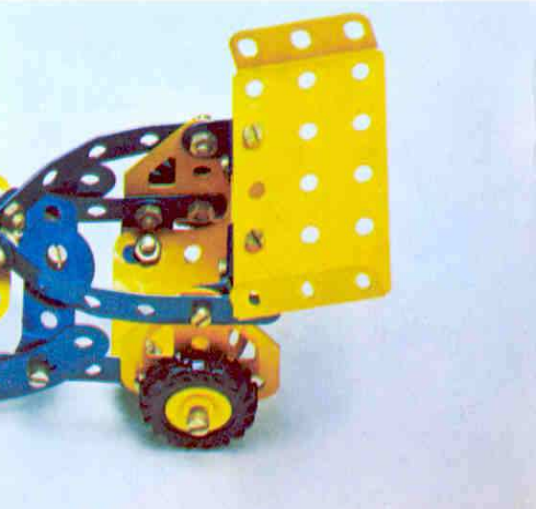

Crane
Grue
kraan
Kran
Kran
Grúa
Gru

1.7

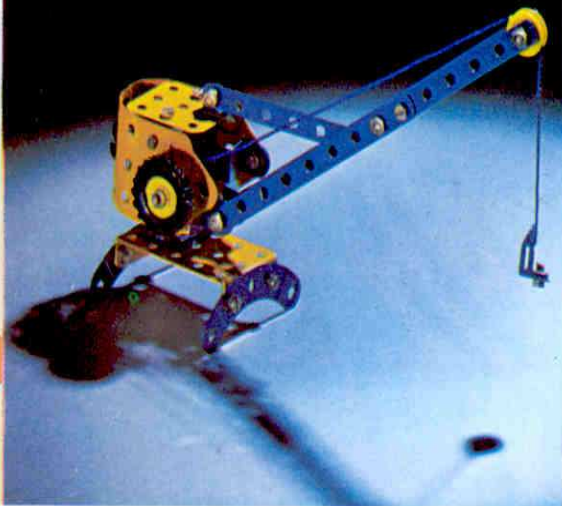
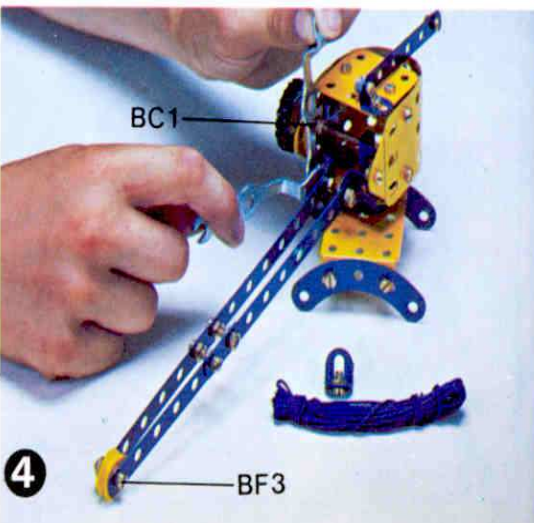
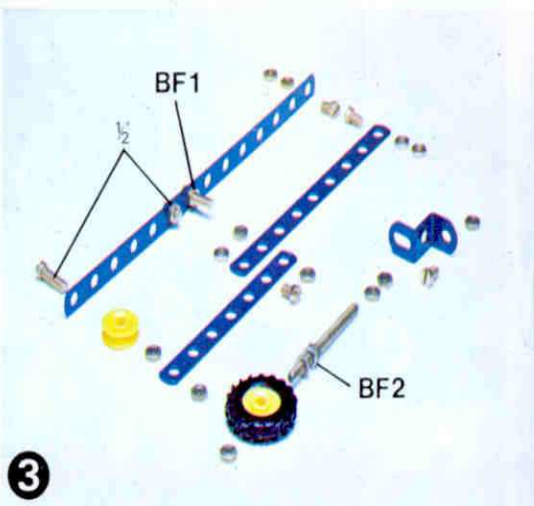
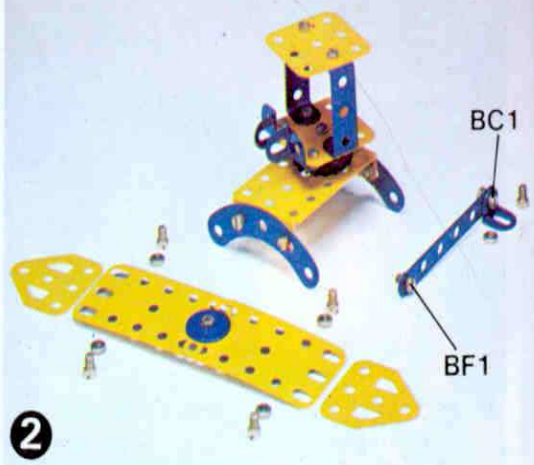

Field Gun

Cannon de campagne
veldgeschut
Feldgeschütz
Felt-Kanon
Cañon
Cannone de campagna

1.8

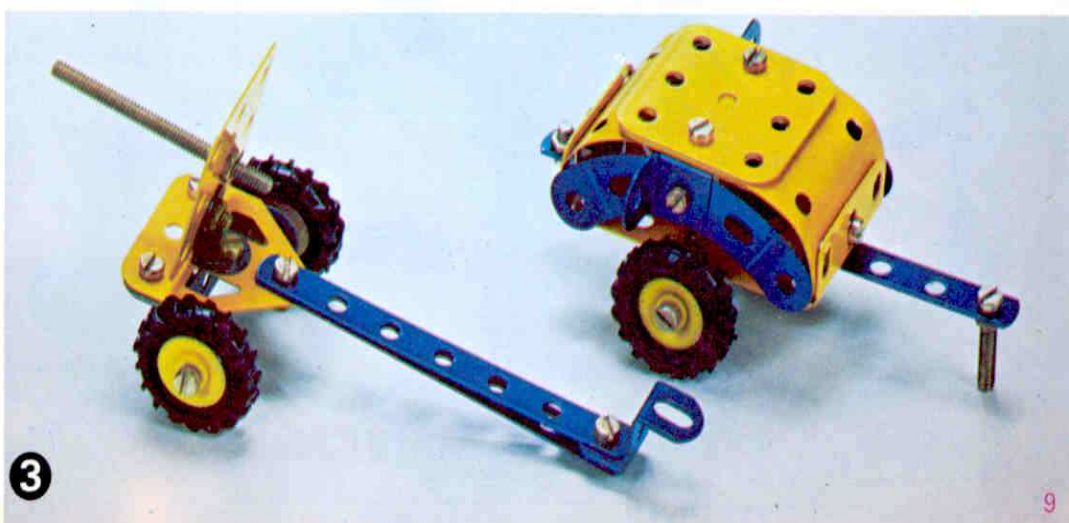
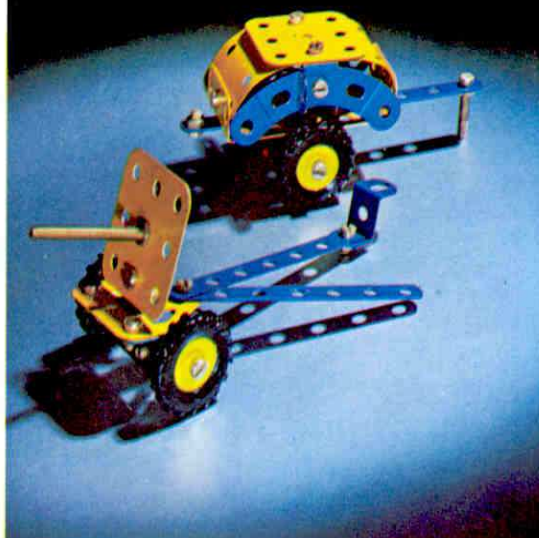
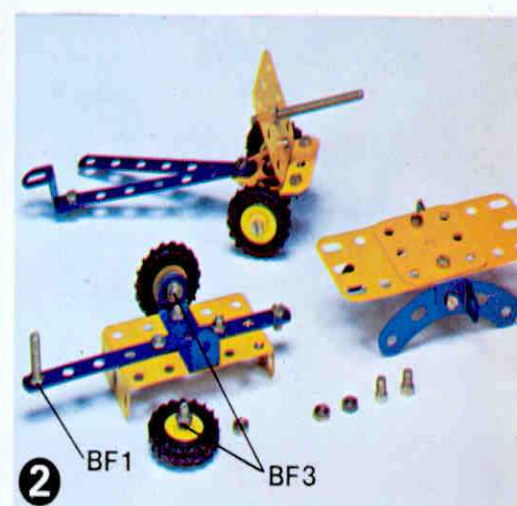
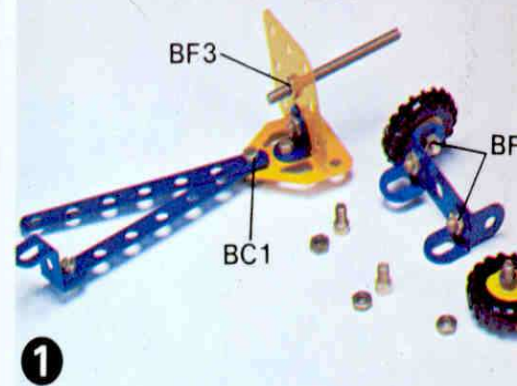

Go Kart
Kart
skelter
Gokart
Go Kart
Gocar
Go-Kart

1.9

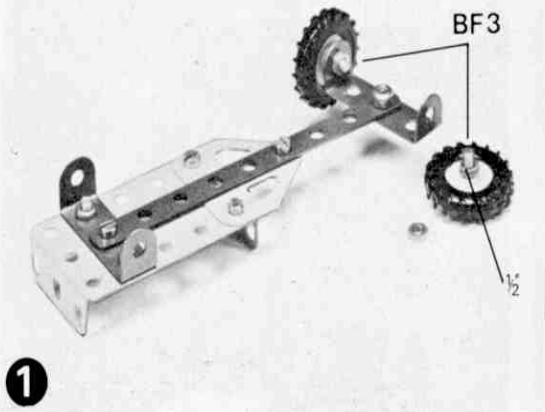

1

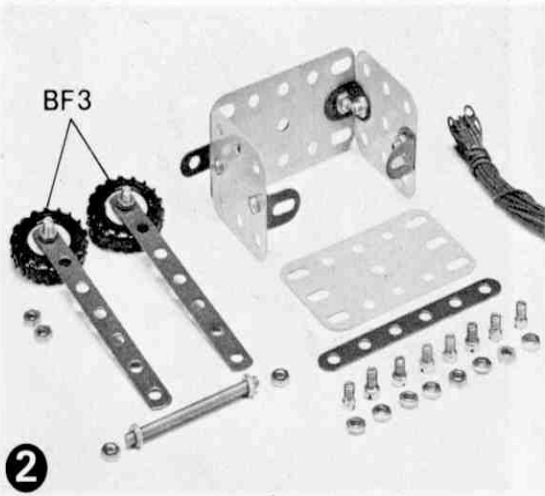

2

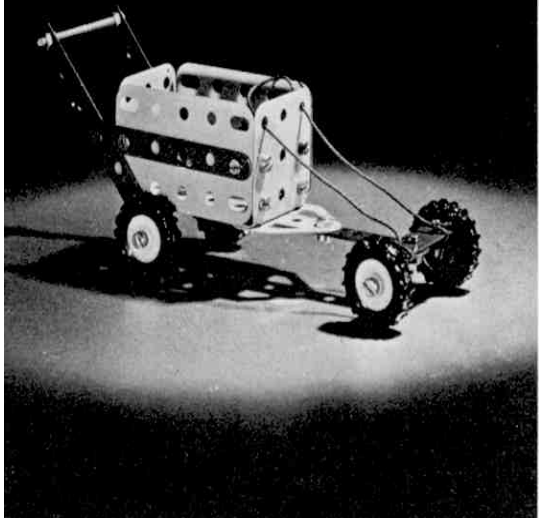

Breakdown-Truck
Dépanneuse
takelwagen
Abschleppwagen
Service Bil
Grúa para Carros malogrados
Autosoccorso

1.10

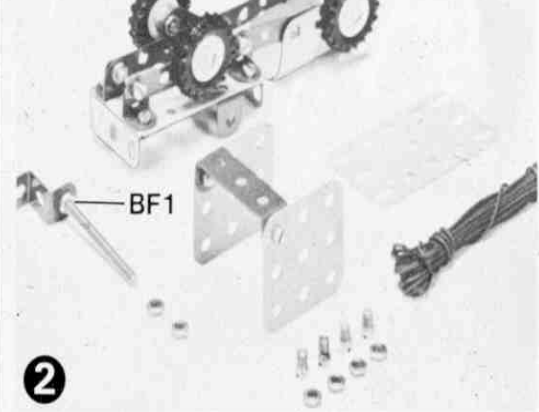
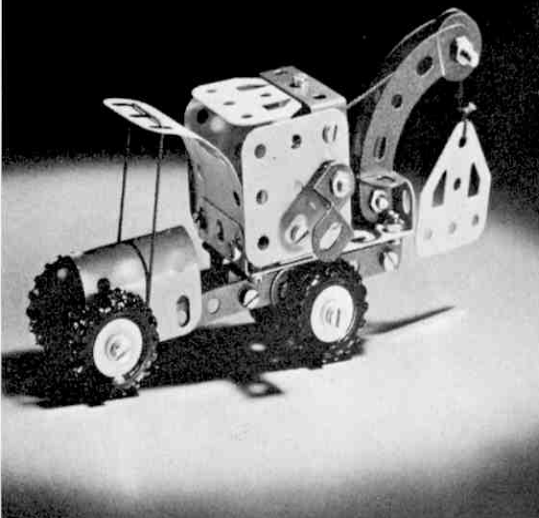

2

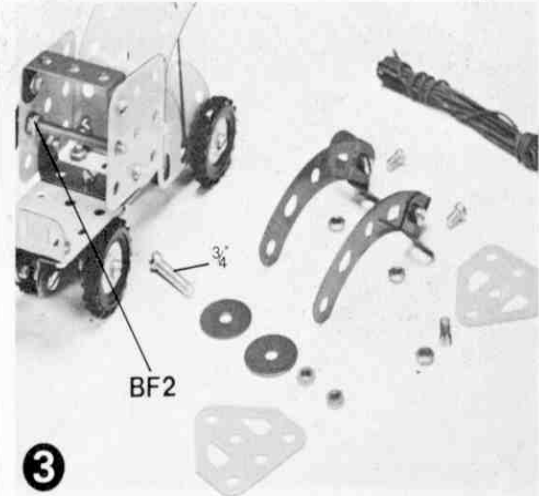

3

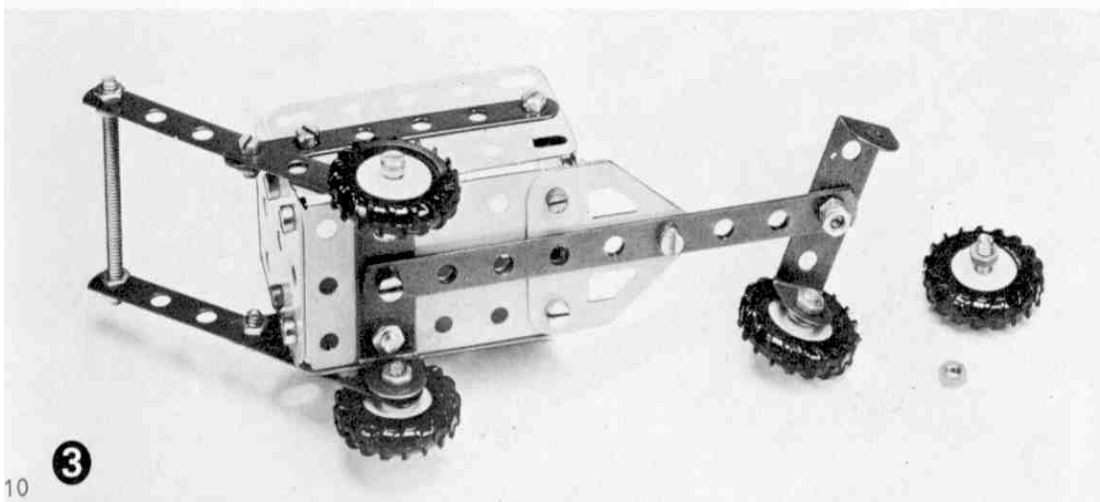

3

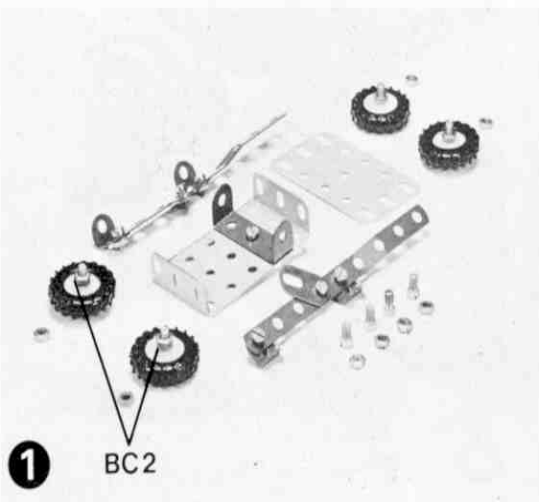

1

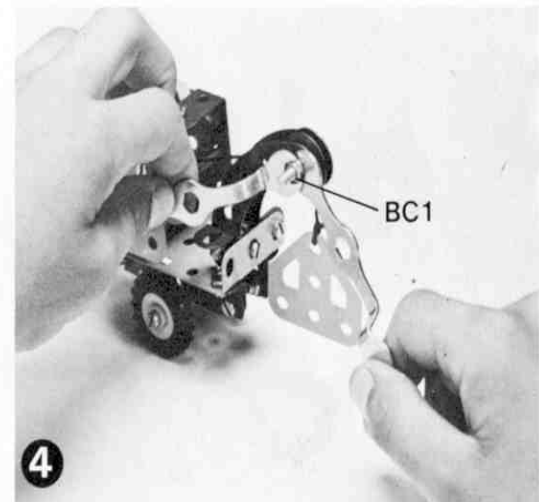

4

Pocket Meccano Models

TV Camera

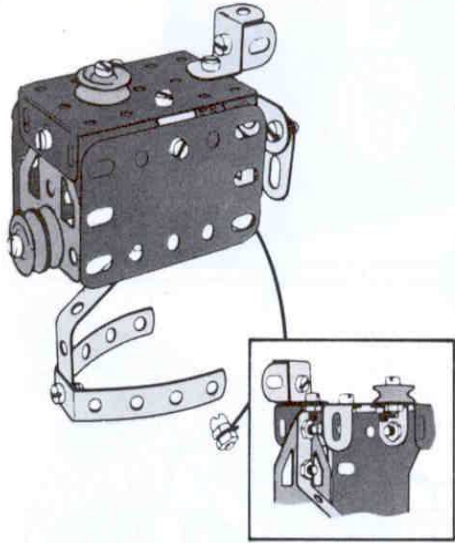

Sewing Machine

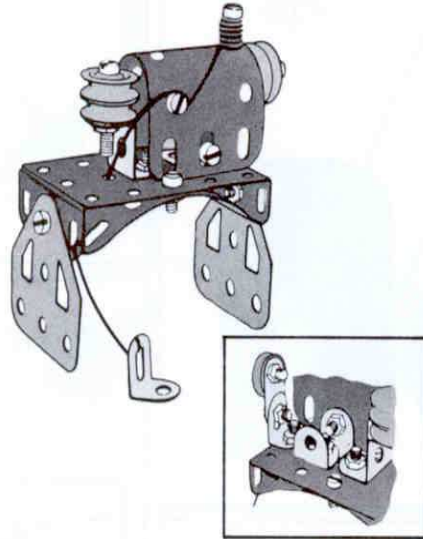

Letter Balance

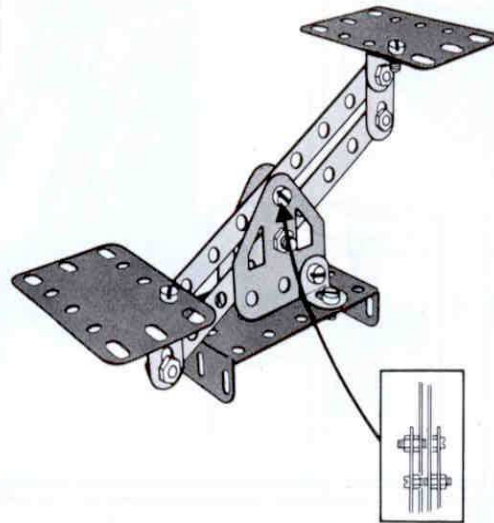

Lawn Mower

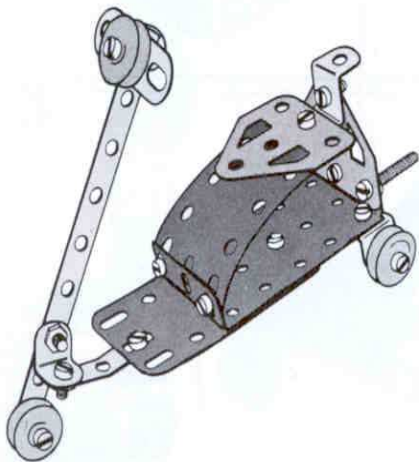
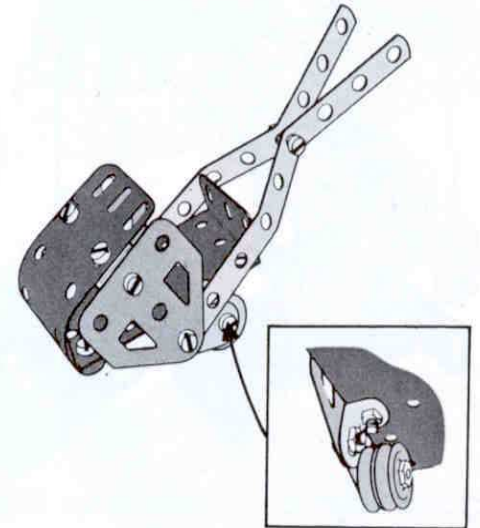

Motor Scooter

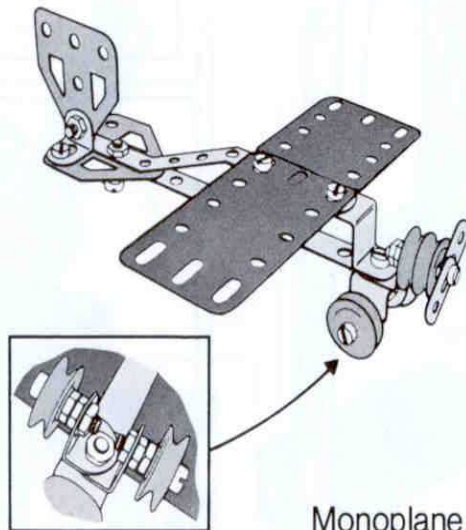

Monoplane

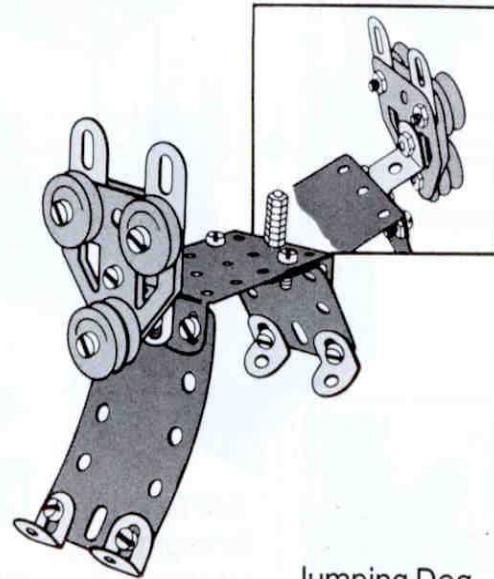

Jumping Dog

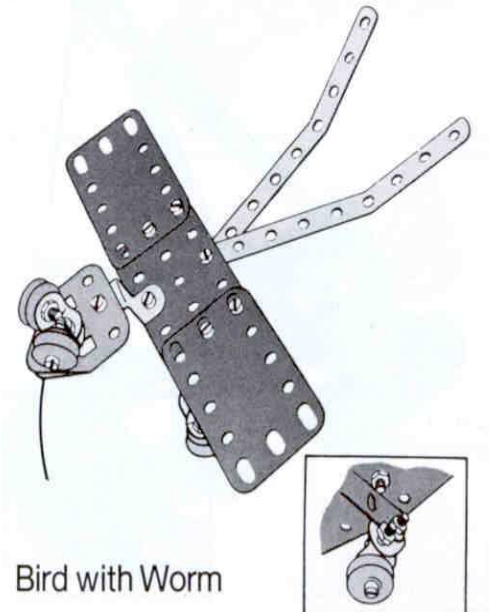

Bird with Worm

Crane

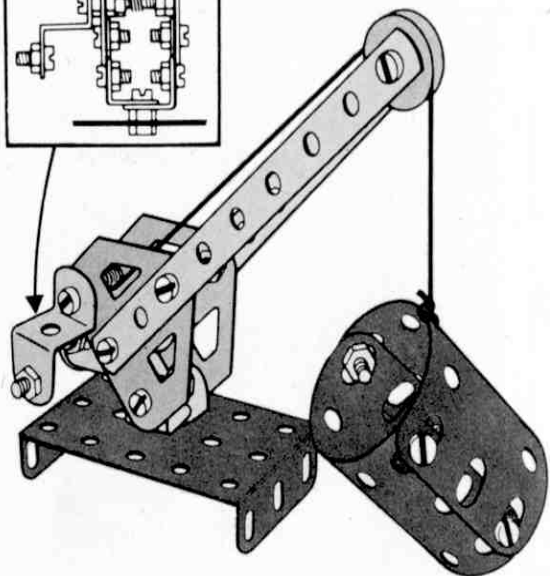
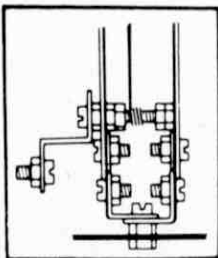

Elevating Platform Trolley

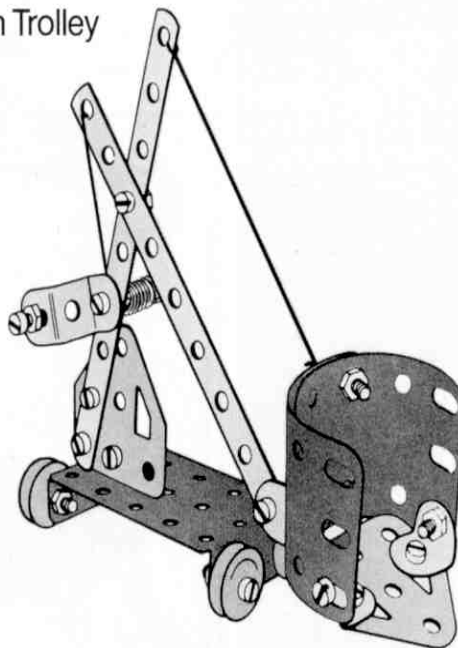
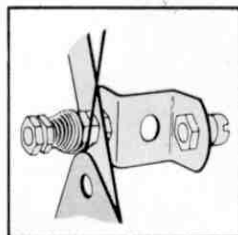

Flash Camera

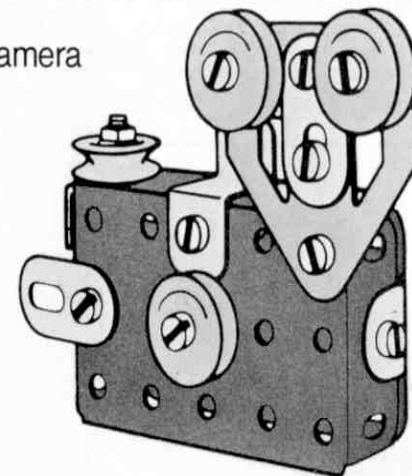

Cable Car

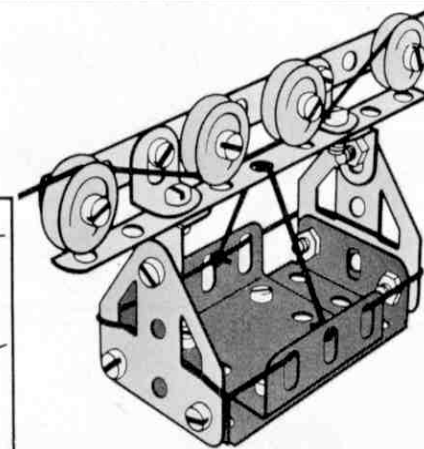
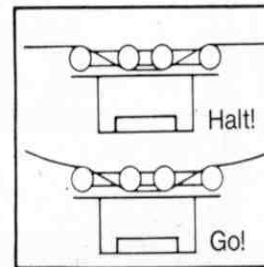

Rotary Mower

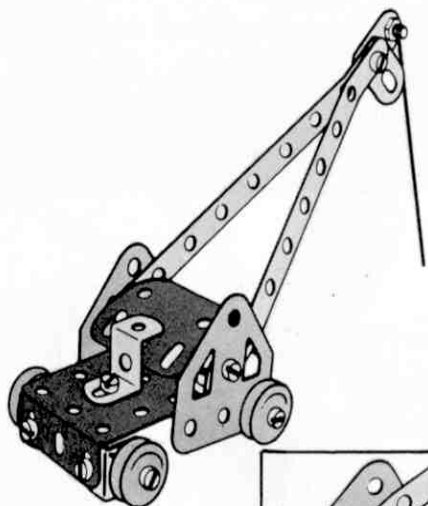
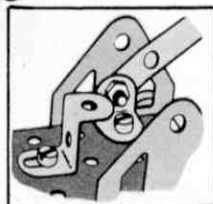

"Test-Your-Strength" Machine

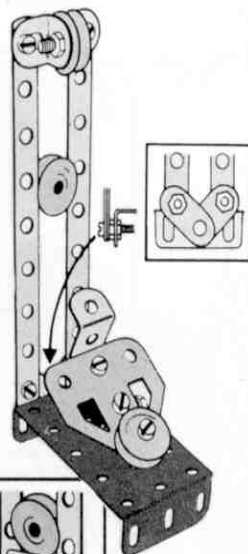
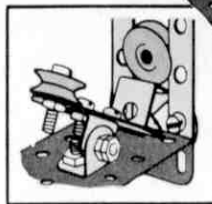

Garden Swing

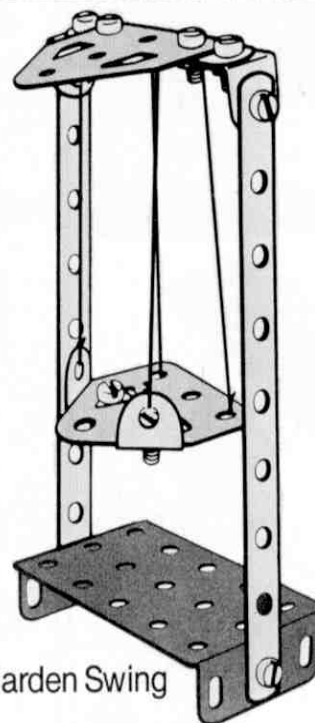

Vintage Truck

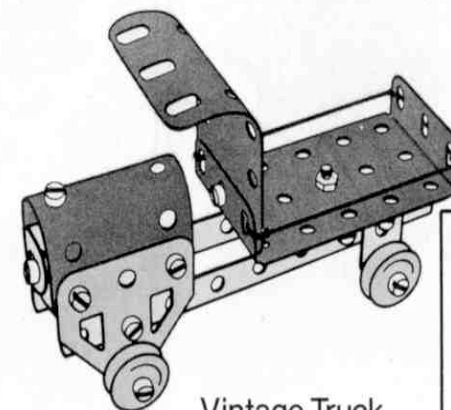
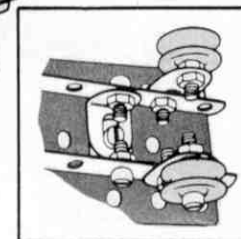

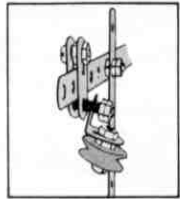
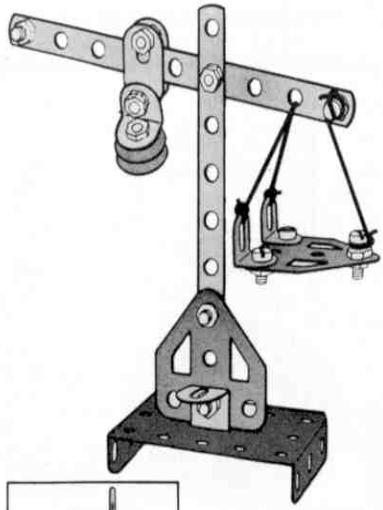

Scales

Bicycle

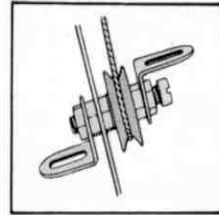
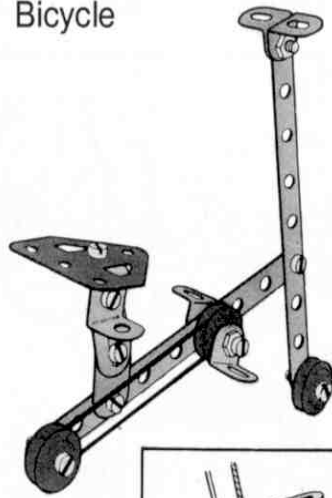

Fly Press

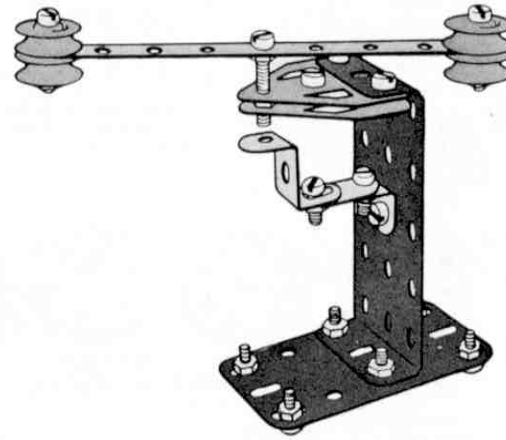

Bobsleigh

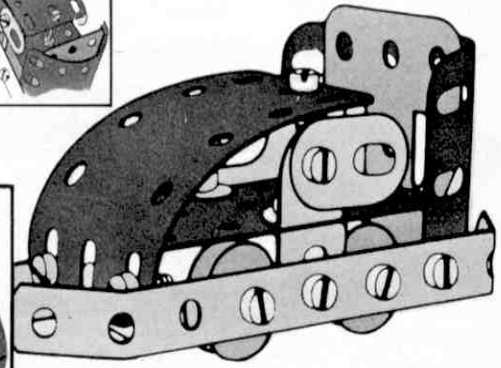
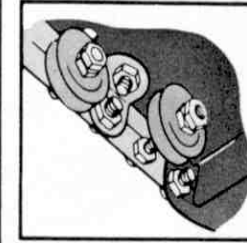
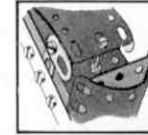

Moon Buggy

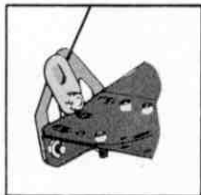
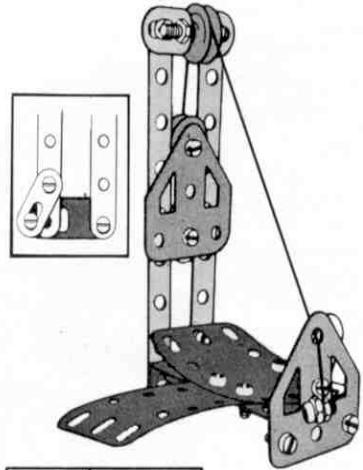
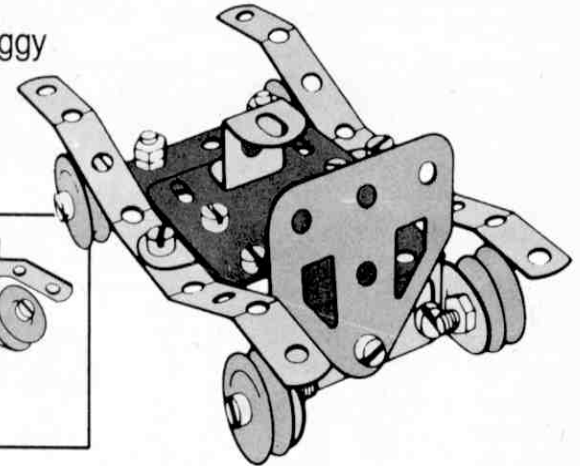
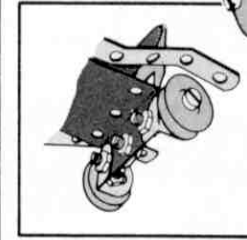

Guillotine

Vacuum Cleaner

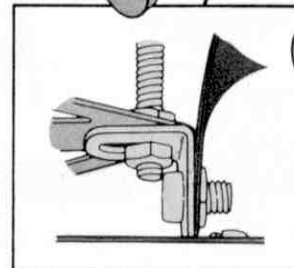
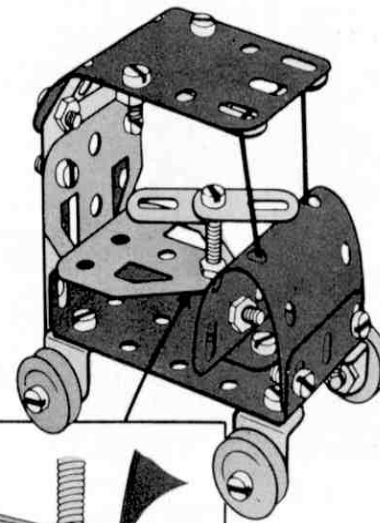
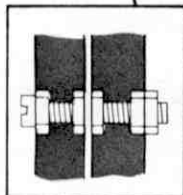
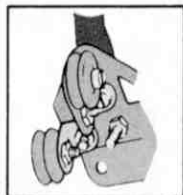
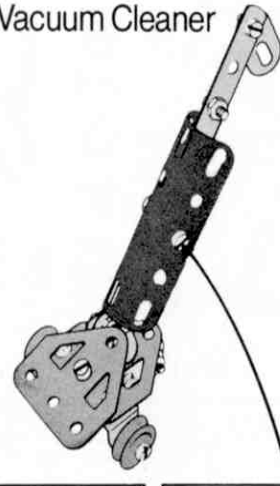

Veteran Car

Helicopter

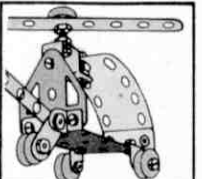
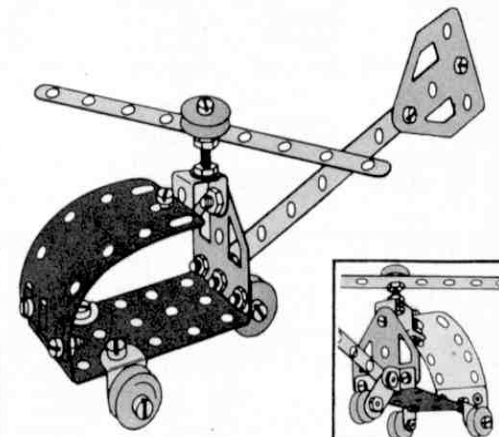
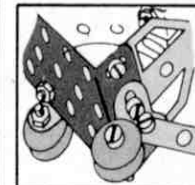

Complete list of Meccano Parts

Liste complète des pièces Meccano

Fullständig förteckning över Meccanodelar

Vollständige Liste der Meccano-Teile

Lista completa de piezas de Meccano

Distinta delle componenti del Corredo Meccano

Komplete lijst van Meccano-onderdelen

PERFORATED STRIPS
 1 - 12½; 32 cm
 1a - 9½; 24 cm
 1b - 7½; 19 cm
 2 - 5½; 14 cm
 2a - 4½; 11½ cm
 3 - 3½; 9 cm
 4 - 3; 7½ cm
 5 - 2½; 6 cm
 6 - 2; 5 cm
 6a 1½; 38 mm
 7 - 24½; 62 cm
 7a - 18½; 47 cm
 8 - 12½; 32 cm
 8a - 9½; 24 cm
 8b - 7½; 19 cm
 9 - 5½; 14 cm
 9a - 4½; 11½ cm
 9b - 3½; 9 cm
 9c - 3; 7½ cm
 9d - 2½; 6 cm
 9e - 2; 5 cm
 9f - 1½; 38 mm

ANGLE GIRDERS
 7a - 18½; 47 cm
 7b - 12½; 32 cm
 7c - 9½; 24 cm
 7d - 7½; 19 cm
 7e - 5½; 14 cm
 7f - 4½; 11½ cm

FISHPLATE
 10

DOUBLE BRACKET
 11a - 1" x ½"; 25 x 12 mm
 11b - 1" x ½"; 25 x 25 mm
 11c - 1" x ½"; 25 x 12 mm

ANGLE BRACKETS
 12 - ½" x ½"; 12 x 12 mm
 12a - 1" x 1"; 25 x 25 mm
 12b - 1" x ½"; 25 x 12 mm
 12c - ½" x ½"; 12 x 12 mm

ANGLE BRACKET (OBTUSE)
 12c - ½" x ½"; 12 x 12 mm

AXLE RODS
 13 - 11½; 29 cm
 13a - 8"; 20 cm
 14 - 6½; 16½ cm
 14a - 5½; 14 cm
 15 - 5"; 13 cm
 15a - 4½; 11½ cm
 15b - 4"; 10 cm
 16 - 3½; 9 cm
 16a - 2½; 6 cm
 16b - 3"; 7½ cm
 17 - 2"; 5 cm
 18a - 1½; 38 mm
 18b - 1"; 25 mm

PULLEYS
 19b - 3"; 75 mm
 20a - 2"; 5 cm

PULLEY
 6"; 153 mm
 19d

CRANK HANDLE
 19h - 5"; 13 cm
 19s - 3½"; 9 cm

FLANGED WHEELS
 20 - 1½"; 28 mm
 20b - ¾"; 19 mm

PULLEY
 21 - 1½"; 38 mm

PULLEY
 22 - 1"; 25 mm

PULLEYS
 22a - 1"; 25 mm
 23 plastic - ½"; 12 mm
 23a metal - ½"; 12 mm
 23 & 23b

BUSH WHEEL
 24 - 1½"; 34 mm

WHEEL DISC
 24a - 1½"; 34 mm

BUSH WHEEL
 24b - 1½"; 34 mm

WHEEL DISC
 24c - 1½"; 34 mm

PINIONS
 25 - 19 x 6 mm
 25a - 19 x 12 mm
 25b - 19 x 19 mm
 26 - 12 x 6 mm
 26a - 12 x 12 mm
 26b - 12 x 19 mm
 26c - 11 x 6 mm

GEAR WHEELS
 27 - 32 mm
 27a - 38 mm
 27d - 41 mm

GEAR WHEELS
 27b - 3½"; 9 cm
 27c - 2½"; 6 cm

MULTI-PURPOSE GEAR WHEEL
 27f

CONTRATE WHEEL
 28 - 1½"; 38 mm
 29 - ¾"; 19 mm

BEVEL GEAR
 For use in pairs.
 30 - ¾"; 22 mm

BEVEL GEARS
 can only be used together.
 30a - ½"; 12 mm
 30c - 1½"; 38 mm

GEAR WHEEL
 31 - 1" x ½"
 25 mm x 6 mm

WORM
 32 - ½"; 12 mm

SPANNER
 34c

35 SPRING CLIP

SCREWDRIVER
 36b

BOX SPANNER
 34b

NUT AND BOLT
 37c

WASHERS
 38 - 10 mm
 38d - 19 mm

HANK OF CORD
 40

TENSION SPRING
 43 - 2"; 5 cm

DOUBLE ANGLE STRIPS
 46 - 2½" x 1"; 60 x 25 mm
 47 - 2½" x 1½"; 60 x 38 mm
 47a - 3" x 1½"; 75 x 38 mm
 48 - 1½" x 1"; 38 x 12 mm
 48a - 2½" x 1"; 60 x 12 mm
 48b - 3" x 1"; 90 x 12 mm
 48c - 4" x 1"; 115 x 12 mm
 48d - 5" x 1"; 140 x 12 mm

DOUBLE BENT STRIP
 45

SLIDE PIECE
 50

FLANGED PLATES
 51 - 2½" x 1½"; 60 x 38 mm
 52 - 5½" x 2½"; 14 x 6 cm
 53 - 3½" x 2½"; 9 x 6 cm

FLAT PLATES
 52a - 5½" x 3½"; 14 x 9 cm
 53a - 4½" x 2½"; 11½ x 6 cm

FLANGED SECTOR PLATE
 54 - 4½"; 115 mm

PERFORATED SLOTTED STRIP
 55 - 5½"; 14 cm
 55a - 2"; 5 cm

HOOK
 57c

PULLEY HOOK
 57e

SPRING CORD
 -40"; 1 metre

COUPLING SCREW FOR 58
 58a

HOOK FOR 58
 58b

COLLAR WITH SCREW
 59

CRANK
 62

THREADED CRANK
 62a

COUPLING
 63

THREADED COUPLING
 63c

THREADED BOSS
 64

DOUBLE ARM CRANK
 62b

STRIP COUPLING
 63b

SHORT COUPLING
 63d

GRUB SCREWS
 69a - ½"; 4 mm
 69b - ⅜"; 5 mm
 69c - ¼"; 3 mm

GRUB SCREWS
 70 - 5½" x 2½"; 14 x 6 cm
 72 - 2½" x 2½"; 6 x 6 cm
 73 - 3" x 1½"; 75 x 38 mm
 74 - 1½" x 1½"; 38 x 38 mm

FLAT PLATES
 70 - 5½" x 2½"; 14 x 6 cm
 72 - 2½" x 2½"; 6 x 6 cm
 73 - 3" x 1½"; 75 x 38 mm
 74 - 1½" x 1½"; 38 x 38 mm

TRIANGULAR PLATES
 76 - 2½"; 6 cm
 77 - 1"; 25 mm

SCREWED RODS
 78 - 11½; 29 cm
 80 - 5"; 12½ cm
 80c - 3"; 7½ cm
 81 - 2"; 5 cm
 82 - 1"; 25 mm

CURVED STRIP
 89 - 5½"; 14 cm
 90 - 2½"; 6 cm

CURVED STRIP STEPPED
 89a - 3"; 7½ cm
 89b - 4"; 10 cm
 90a - 2½"; 6 cm

SPROCKET CHAIN
 94 - 40"; 1 metre

SPROCKET WHEELS
 95 - 2"; 5 cm
 95a - 1½"; 38 mm
 95b - 3"; 75 mm
 96 - 1"; 25 mm
 96a - ¾"; 19 mm

BRACED GIRDERS
 97 - 3½"; 9 cm
 99 - 12½"; 32 cm
 99a - 9½"; 24 cm
 99b - 7½"; 19 cm
 100 - 5½"; 14 cm

SINGLE BENT STRIP
 102

FLAT GIRDERS
 103 - 5½"; 14 cm
 103a - 9½"; 24 cm
 103b - 12½"; 32 cm
 103c - 4½"; 11½ cm
 103d - 3½"; 9 cm
 103e - 3"; 7½ cm
 103f - 2½"; 6 cm
 103g - 2"; 5 cm
 103h - 1½"; 38 mm
 103i - 1"; 25 mm
 103j - ¾"; 19 cm
 103k - ½"; 12 mm

CORNER GUSSET
 108

FACE PLATE
 109 - 2½"; 6 cm

RACK STRIPS
 110 - 3½"; 9 cm
 110a - 6½"; 16½ cm

BOLTS
 111 - 2"; 19 mm
 111a - 1"; 12 mm
 111c - ¾"; 9 mm
 111d - 1½"; 28½ mm

GIRDER FRAME
 113

HINGE
 114

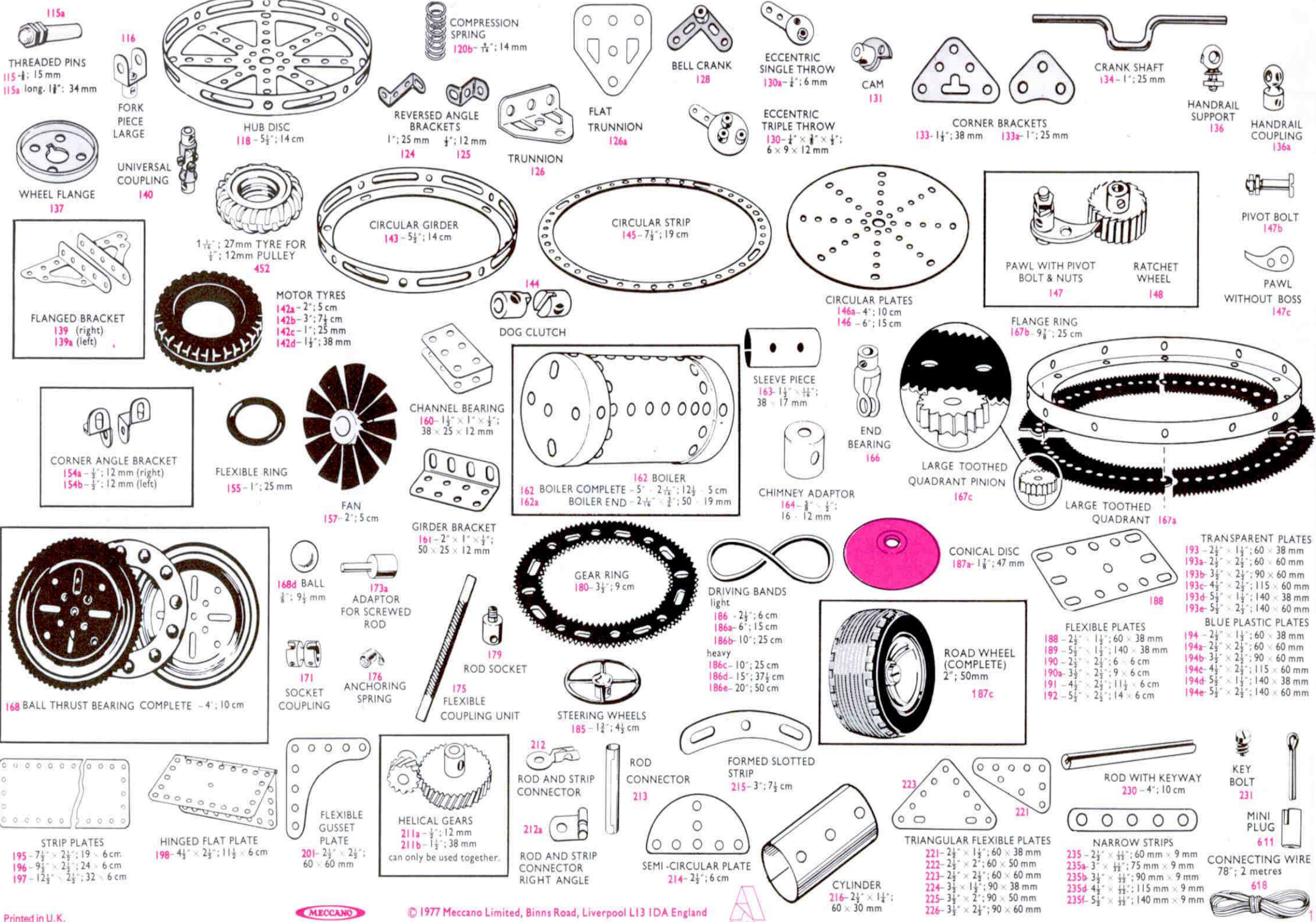

115a
 THREADED PINS
 115 - 1/4"; 15 mm
 115a long. 1 1/4"; 34 mm

116
 FORK
 PIECE
 LARGE

HUB DISC
 118 - 5 1/2"; 14 cm

COMPRESSION
 SPRING
 120b - 1/4"; 14 mm

REVERSED ANGLE
 BRACKETS
 124 - 1"; 25 mm
 125 - 1/2"; 12 mm

FLAT
 TRUNNION
 126a

BELL CRANK
 128

ECCENTRIC
 SINGLE THROW
 130a - 1/2"; 6 mm

CAM
 131

CORNER BRACKETS
 133 - 1 1/4"; 38 mm
 133a - 1"; 25 mm

CRANK SHAFT
 134 - 1"; 25 mm

HANDRAIL
 SUPPORT
 136

HANDRAIL
 COUPLING
 136a

WHEEL FLANGE
 137

UNIVERSAL
 COUPLING
 140

1 1/4"; 27 mm TYRE FOR
 1/2"; 12 mm PULLEY
 452

CIRCULAR GIRDER
 143 - 5 1/2"; 14 cm

CIRCULAR STRIP
 145 - 7 1/2"; 19 cm

ECCENTRIC
 TRIPLE THROW
 130 - 1/2" x 1/2" x 1/2";
 6 x 9 x 12 mm

PAWL WITH PIVOT
 BOLT & NUTS
 147

RATCHET
 WHEEL
 148

PIVOT BOLT
 147b

PAWL
 WITHOUT BOSS
 147c

FLANGED BRACKET
 139 (right)
 139a (left)

MOTOR TYRES
 142a - 2"; 5 cm
 142b - 3"; 7 1/2 cm
 142c - 1"; 25 mm
 142d - 1 1/2"; 38 mm

DOG CLUTCH
 144

CHANNEL BEARING
 160 - 1 1/2" x 1" x 1/2";
 38 x 25 x 12 mm

162 BOILER
 162 BOILER COMPLETE - 5" - 2 1/2"; 12 1/2" - 5 cm
 162a BOILER END - 2 1/4" x 1/2"; 50 - 19 mm

SLEEVE PIECE
 163 - 1 1/2" x 1/4";
 38 x 17 mm

END BEARING
 166

CIRCULAR PLATES
 146a - 4"; 10 cm
 146 - 6"; 15 cm

FLANGE RING
 167b - 9 1/2"; 25 cm

LARGE TOOTHED
 QUADRANT PINION
 167c

LARGE TOOTHED
 QUADRANT
 167a

CORNER ANGLE BRACKET
 154a - 1/2"; 12 mm (right)
 154b - 1/2"; 12 mm (left)

FLEXIBLE RING
 155 - 1"; 25 mm

FAN
 157 - 2"; 5 cm

GIRDER BRACKET
 161 - 2" x 1" x 1/2";
 50 x 25 x 12 mm

CHIMNEY ADAPTOR
 164 - 3/4" x 1/2";
 16 - 12 mm

CONICAL DISC
 187a - 1 1/4"; 47 mm

TRANSPARENT PLATES
 193 - 2 1/2" x 1 1/2"; 60 x 38 mm
 193a - 2 1/2" x 2 1/2"; 60 x 60 mm
 193b - 3 1/2" x 2 1/2"; 90 x 60 mm
 193c - 4 1/2" x 2 1/2"; 115 x 60 mm
 193d - 5 1/2" x 1 1/2"; 140 x 38 mm
 193e - 5 1/2" x 2 1/2"; 140 x 60 mm

168 BALL THRUST BEARING COMPLETE - 4"; 10 cm

168d BALL
 3/8"; 9 1/2 mm

173a ADAPTOR
 FOR SCREWED
 ROD

171 SOCKET
 COUPLING

176 ANCHORING
 SPRING

175 FLEXIBLE
 COUPLING UNIT

179 ROD SOCKET

GEAR RING
 180 - 3 1/2"; 9 cm

DRIVING BANDS
 light
 186 - 2 1/2"; 6 cm
 186a - 6"; 15 cm
 186b - 10"; 25 cm
 heavy
 186c - 10"; 25 cm
 186d - 15"; 37 1/2 cm
 186e - 20"; 50 cm

ROAD WHEEL
 (COMPLETE)
 2"; 50 mm
 187c

BLUE PLASTIC PLATES
 194 - 2 1/2" x 1 1/2"; 60 x 38 mm
 194a - 2 1/2" x 2 1/2"; 60 x 60 mm
 194b - 3 1/2" x 2 1/2"; 90 x 60 mm
 194c - 4 1/2" x 2 1/2"; 115 x 60 mm
 194d - 5 1/2" x 1 1/2"; 140 x 38 mm
 194e - 5 1/2" x 2 1/2"; 140 x 60 mm

STRIP PLATES
 195 - 7 1/2" x 2 1/2"; 19 x 6 cm
 196 - 9 1/2" x 2 1/2"; 24 x 6 cm
 197 - 12 1/2" x 2 1/2"; 32 x 6 cm

HINGED FLAT PLATE
 198 - 4 1/2" x 2 1/2"; 11 1/2 x 6 cm

FLEXIBLE GUSSET
 PLATE
 201 - 2 1/2" x 2 1/2";
 60 x 60 mm

HELICAL GEARS
 211a - 1 1/2"; 12 mm
 211b - 1 1/2"; 38 mm
 can only be used together.

212 ROD AND STRIP
 CONNECTOR

212a ROD AND STRIP
 CONNECTOR
 RIGHT ANGLE

ROD CONNECTOR
 213

SEMI-CIRCULAR PLATE
 214 - 2 1/2"; 6 cm

FORMED SLOTTED
 STRIP
 215 - 3"; 7 1/2 cm

CYLINDER
 216 - 2 1/2" x 1 1/4";
 60 x 30 mm

TRIANGULAR FLEXIBLE PLATES
 221 - 2 1/2" x 1 1/2"; 60 x 38 mm
 222 - 2 1/2" x 2"; 60 x 50 mm
 223 - 2 1/2" x 2 1/2"; 60 x 60 mm
 224 - 3 1/2" x 1 1/2"; 90 x 38 mm
 225 - 3 1/2" x 2"; 90 x 50 mm
 226 - 3 1/2" x 2 1/2"; 90 x 60 mm

ROD WITH KEYWAY
 230 - 4"; 10 cm

NARROW STRIPS
 235 - 2 1/2" x 1/4"; 60 mm x 9 mm
 235a - 3" x 1/4"; 75 mm x 9 mm
 235b - 3 1/2" x 1/4"; 90 mm x 9 mm
 235d - 4 1/2" x 1/4"; 115 mm x 9 mm
 235f - 5 1/2" x 1/4"; 140 mm x 9 mm

KEY BOLT
 231

MINI PLUG
 611

CONNECTING WIRE
 78"; 2 metres
 618

Contents of Meccano Sets

© 1978 Meccano Ltd. Binns Road, Liverpool L13 1DA, England

PRINTED IN ENGLAND

MADE BY **MECCANO** ENGLAND



160048

Description of Parts	Part Sales No.	Number of Parts per Set								
		A	1	2	3	4	5	EXT S	EXT L	
Perforated Strip	7½"	1B	-	2	2	2	2	2	2	-
" "	5½"	2	-	2	2	4	4	6	4	2
" "	4½"	2A	-	-	-	-	-	2	-	2
" "	2½"	5	-	-	-	-	4	4	-	4
" "	2"	6	-	-	2	2	2	2	2	-
Angle Girder	12½"	8	-	2	-	-	-	4	-	4
" "	9½"	8A	-	-	-	-	4	4	-	4
" "	5½"	9	-	-	2	2	2	2	2	-
" "	4½"	9A	-	-	-	-	-	2	-	2
" "	3½"	9B	-	-	-	-	-	2	-	2
" "	1½"	9F	-	-	2	2	2	2	2	-
Fishplate		10	2	2	2	2	4	4	-	2
Double Bracket	½ x ½"	11	-	-	-	-	2	2	-	2
" "	1" x ½"	11A	-	-	-	-	1	1	-	1
Angle Bracket	½" x ½"	12	4	4	4	4	6	8	-	4
" "	1" x ½"	12B	-	-	2	2	2	2	2	-
Obtuse Angle Bracket	½" x ½"	12C	-	-	-	4	4	4	4	-
Axle Rod	11½"	13	-	-	-	-	1	1	-	1
" "	5½"	14A	-	-	-	-	-	1	-	1
" "	4"	15B	-	-	-	2	2	3	2	1
" "	3½"	16	-	-	1	1	1	1	1	-
" "	2½"	16A	-	1	2	2	2	2	2	-
" "	3"	16B	-	-	-	-	1	1	-	1
" "	2"	17	-	-	-	-	-	2	-	2
" "	1½"	18A	-	-	-	1	1	1	1	-
Pulley	3"	19B	-	-	-	-	2	2	-	2
" "	1½"	21	-	-	2	2	2	2	2	-
" "	1"	22	-	-	-	2	2	2	2	-
" Plastic	½"	23	4	4	4	4	4	4	-	-
Bush Wheel 8 Hole	1½"	24	-	-	-	-	-	1	-	1
" " 6 Hole	1⅞"	24B	-	-	-	-	1	1	-	1
Pinion	½" x ¼"	26	-	-	1	1	1	2	1	1
Gear Wheel	1½"	27A	-	-	1	1	1	1	1	-
" "	2½"	27C	-	-	-	-	-	1	-	1
Multi Purpose Gear Wheel		27F	-	-	-	2	2	2	2	-
Contrate Wheel	1½"	28	-	-	-	-	1	1	-	1
Worm Wheel		32	-	-	-	-	1	1	-	1
Spanner		34C	2	2	2	2	2	2	-	-
Spring Clip		35	-	-	4	4	4	4	4	-
Screwdriver		36B	1	1	1	1	1	1	-	-
Bolt	¼"	37B	28	63	63	90	110	150	62	60
Nut		37C	40	75	75	132	162	218	92	92
Washer	⅜"	38	-	-	20	20	40	50	20	30
" "	¾"	38D	2	2	2	2	2	6	-	4
Hank of Cord		40	1	1	1	1	1	2	-	1
Double Bent Strip		45	-	-	-	-	2	2	-	2
Double Angle Strip	1½" x ½"	48	2	2	2	4	2	2	2	-
" " "	2½" x ½"	48A	-	-	2	4	4	4	4	-
" " "	3½" x ½"	48B	-	-	-	2	2	2	2	-
Flanged Plate	2½" x 1½"	51	1	1	1	1	1	1	-	-

Description of Parts	Part Sales No.	Number of Parts per Set								
		A	1	2	3	4	5	EXT S	EXT L	
Flanged Plate	3½" x 2½"	53	-	1	1	1	1	1	1	-
Collar		59	-	-	-	-	4	4	-	4
Double Arm Crank		62B	-	-	-	-	-	1	-	1
Grub Screw	⅝"	69A	-	-	2	6	12	14	6	8
Flat Plate	5½" x 2½"	70	-	-	-	1	1	1	1	-
" "	1½" x 1½"	74	2	2	2	2	2	2	-	-
Screwed Rod	3"	80C	-	-	-	-	1	1	1	-
" "	2"	81	1	1	1	1	1	1	-	-
Curved Strip Stepped	2½"	90A	2	2	2	4	4	4	2	-
Flat Girder	4½"	103C	-	-	-	-	-	2	-	2
" "	3½"	103D	-	-	-	-	-	2	-	2
" "	2½"	103F	-	1	2	2	2	4	2	2
" "	1½"	103H	-	-	-	-	-	2	-	2
Face Plate	2½"	109	-	-	-	-	-	2	-	2
Bolt	⅜"	111	1	1	2	4	4	4	3	-
" "	½"	111A	4	4	4	16	16	22	12	12
" "	1⅞"	111D	-	-	-	2	4	4	2	2
Threaded Pin Long	1⅞"	115A	-	-	1	1	1	1	1	-
Compression Spring		120B	-	-	-	-	-	4	-	4
Reversed Angle Bracket	½"	125	1	1	1	1	1	1	-	-
Flat Trunnion		126A	2	2	2	2	2	2	-	-
Corner Bracket	1"	133A	-	-	-	2	2	2	2	-
Wheel Flange		137	-	-	-	-	-	2	-	2
Corner Angle Bracket RH		154A	1	1	1	1	1	1	-	-
" " " LH		154B	1	1	1	1	1	1	-	-
Channel Bearing		160	-	-	1	1	1	1	1	-
Driving Band Light	2½"	186	-	-	-	-	1	1	-	1
Driving Band Light	6"	186A	-	-	2	2	2	2	2	-
" " Light	10"	186B	-	-	-	-	1	1	-	1
Flexible Plate	5½ x 1½"	189	-	-	-	2	2	2	2	-
" "	3½" x 2½"	190A	1	1	2	2	2	2	1	-
Transparent Plate	2½" x 1½"	193	-	-	-	2	2	2	2	-
Plastic Plate	2½" x 1½"	194	4	6	4	3	3	3	-	-
" "	2½" x 2½"	194A	-	2	2	2	2	2	2	-
" "	5½" x 2½"	194E	-	-	-	-	-	3	-	3
Rod Connector		213	-	-	-	-	1	1	-	1
Semi Circular Plate		214	-	-	-	-	-	2	-	2
Formed Slotted Strip	3"	215	-	-	-	2	2	2	2	-
Narrow Strip	2½"	235	-	-	-	4	4	4	4	-
" "	3"	235A	2	2	2	2	2	2	-	-
" "	3½"	235B	2	2	2	2	2	2	-	-
" "	4½"	235D	2	2	2	2	2	2	-	-
" "	1½"	235G	-	-	-	-	-	4	-	4
Tyre for ½" pulley	1⅞"	13452	4	4	4	4	4	4	-	-
Miniature Plug		611	-	-	4	4	4	4	-	-
Connecting Wire		618	-	-	1	1	1	1	-	-
4.5v Motor		11053	-	-	1	1	1	1	-	-
3v Battery Box		13624	-	-	1	1	1	1	-	-
Road Wheel (Complete)		187C	-	-	-	4	4	6	4	4
Hook		57C	1	1	1	1	1	1	-	-