





















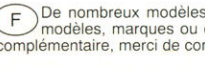

- 1  x3 036001
- 1a  x4 036002
- 1b  x4 036003
- 2  x6 036004
- 2a  x6 036457
- 2b  x6 036005
- 2c  x6 036456
- 2d  x6 036006
- 2e  x6 036458
- 2f  x6 036459
- 3  x6 036007
- 3a  x6 036460
- 3b  x6 036461
- 3c  x6 036462
- 4  x8 036008
- 4a  x8 036463
- 4b  x8 036464
- 4c  x8 036466
- 4d  x8 036465
- 5  x8 036009
- 5a  x8 036467
- 5b  x8 036468
- 6  x10 036010
- 6a  x10 036469
- 6b  x10 036470



- 235d  x8 036522
- 235e  x6 036521
- 235f  x6 036249
- 235g  x6 036520
- 235h  x6 036248
- 235i  x6 036519
- 235j  x6 036430
- 235k  x6 036523
- 235l  x6 036011
- 235m  x2 036012
- 235n  x6 036016
- 235o  x6 036017
- 235p  x6 036018
- 235q  x6 036019
- 235r  x6 036019
- 235s  x6 036020
- 235t  x6 036021
- 235u  x6 036022
- 235v  x6 036535

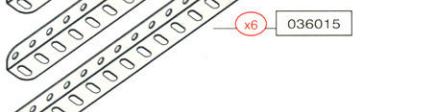
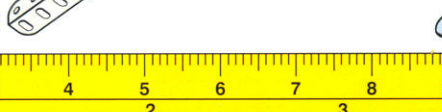

- 7  x2 036013
- 7a  x2 036014
- 7b  x6 036015
- 7c  x6 036015
- 7d  x6 036015
- 7e  x6 036015
- 7f  x6 036015
- 7g  x6 036015
- 7h  x6 036015
- 7i  x6 036015
- 7j  x6 036015
- 7k  x6 036015
- 7l  x6 036015
- 7m  x6 036015
- 7n  x6 036015
- 7o  x6 036015
- 7p  x6 036015
- 7q  x6 036015
- 7r  x6 036015
- 7s  x6 036015
- 7t  x6 036015
- 7u  x6 036015
- 7v  x6 036015
- 7w  x6 036015
- 7x  x6 036015
- 7y  x6 036015
- 7z  x6 036015

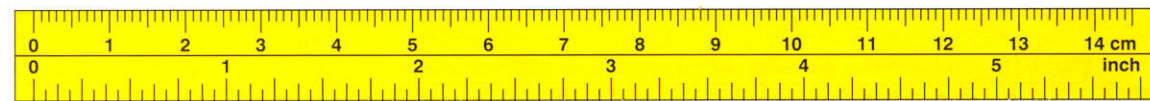

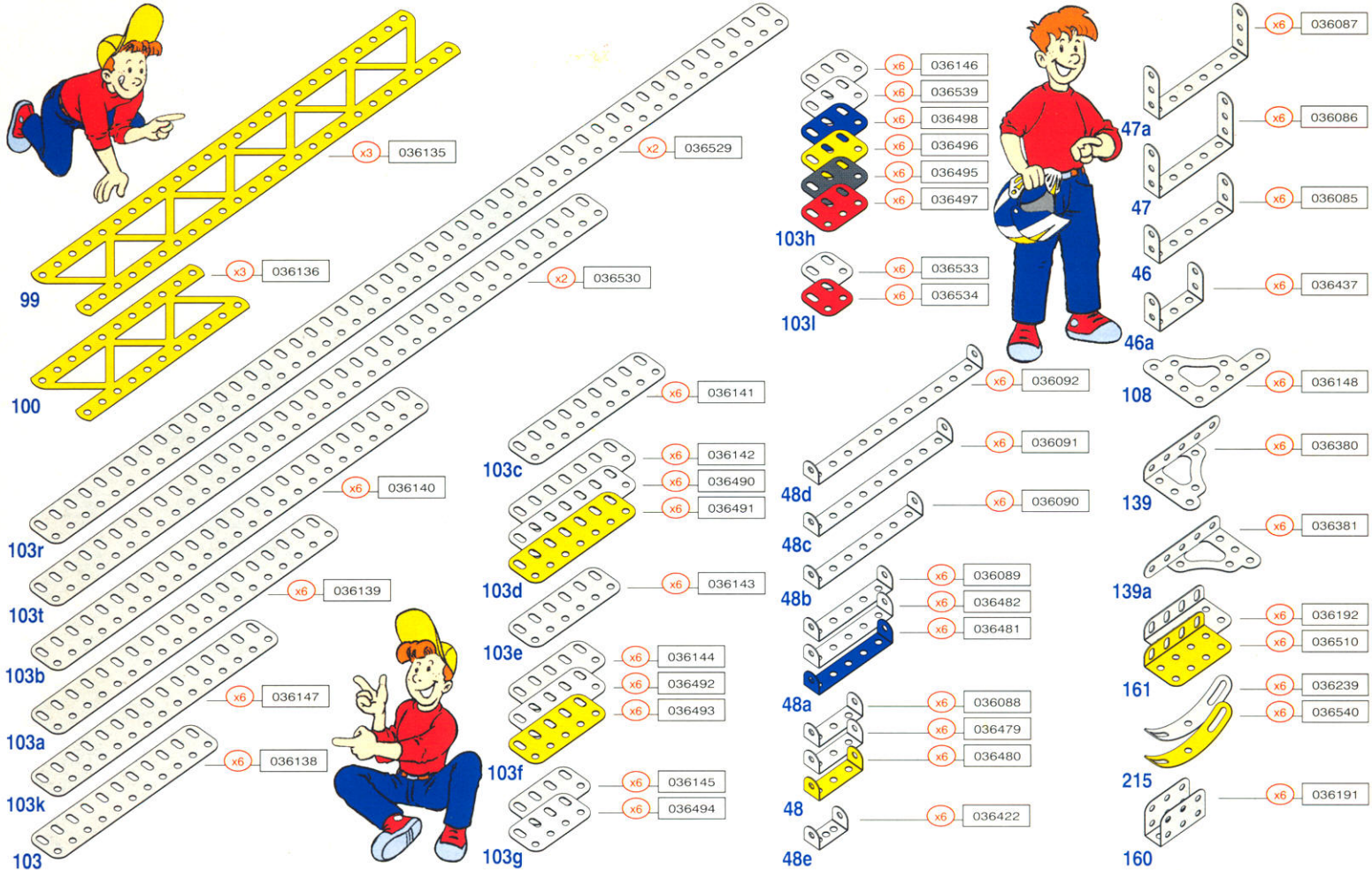

**D** Viele Modelle und Zubehörteile vereinen die Einzigartigkeit und das Originaldesign von MECCANO S.A. Industriedesign. Warenzeichen und/oder Copyrights für viele Modelle und Zubehörteile sind in zahlreichen Ländern gesetzlich geschützt. MECCANO ist ein eingetragenes Warenzeichen von MECCANO S.A. und kann nicht ohne Genehmigung genutzt werden. MECCANO S.A. steht Ihnen für nähere Informationen zur Verfügung  
 MECCANO S.A. 95 bis, rue Bellevue - 92100 BOULOGNE BILLANCOURT - FRANCE Tél.(1) 41.10.09.50 - Fax : (1) 41.10.09.55

**I** Molti modelli e componenti sono realizzati secondo disegni unici e originali di proprietà della MECCANO S.A. Molti di questi modelli e componenti sono protetti dalla legislatura come disegni industriali, marchi e/o copyright in numerosi paesi. Il marchio MECCANO e' registrato come marchio della MECCANO S.A. e può essere utilizzato solo previa autorizzazione. Per ulteriori informazioni rivolgersi alla MECCANO S.A.  
 4 MECCANO S.A. 95 bis, rue Bellevue - 92100 BOULOGNE BILLANCOURT - FRANCE Tél.(1) 41.10.09.50 - Fax : (1) 41.10.09.55



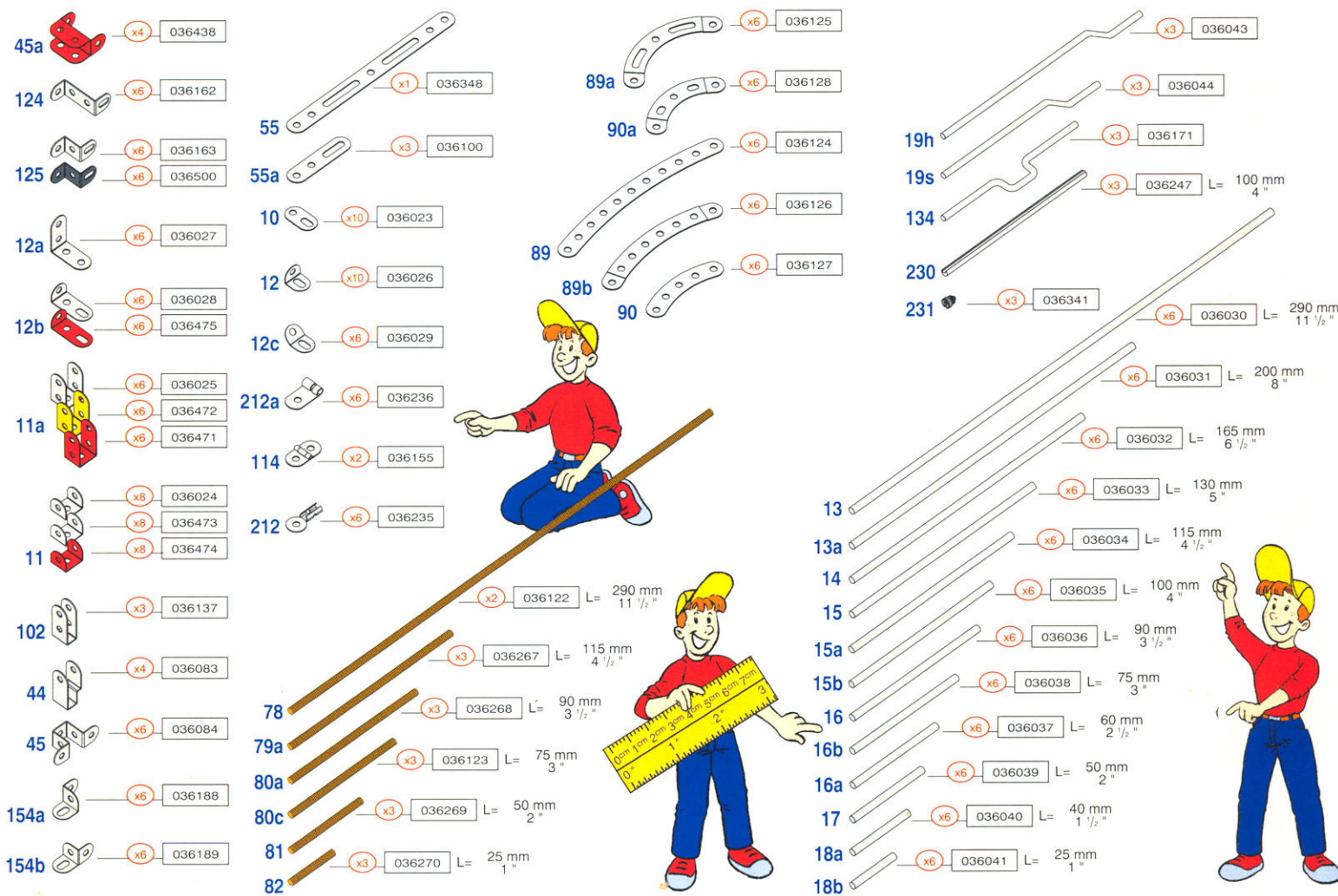

- 45a x4 036438
- 124 x6 036162
- 125 x6 036163
- 125 x6 036500
- 12a x6 036027
- 12b x6 036028
- 12b x6 036475
- 11a x6 036025
- 11a x6 036472
- 11a x6 036471
- 11 x8 036024
- 11 x8 036473
- 11 x8 036474
- 102 x3 036137
- 44 x4 036083
- 45 x6 036084
- 154a x6 036188
- 154b x6 036189

- 55 x1 036348
- 55a x3 036100
- 10 x10 036023
- 12 x10 036026
- 12c x6 036029
- 212a x6 036236
- 114 x2 036155
- 212 x6 036235

- 89a x6 036125
- 89a x6 036128
- 90a x6 036124
- 89 x6 036126
- 89b x6 036127
- 90 x6 036127

- 19h x3 036043
- 19h x3 036044
- 19s x3 036171
- 19s x3 036247 L = 100 mm
- 134 x3 036247 L = 100 mm
- 230 x3 036341
- 231 x3 036341
- 231 x6 036030 L = 290 mm
- 231 x6 036030 L = 11 1/2"
- 231 x6 036031 L = 200 mm
- 231 x6 036031 L = 8"
- 13 x6 036032 L = 165 mm
- 13 x6 036032 L = 6 1/2"
- 13 x6 036033 L = 130 mm
- 13 x6 036033 L = 5"
- 13a x6 036034 L = 115 mm
- 13a x6 036034 L = 4 1/2"
- 14 x6 036035 L = 100 mm
- 14 x6 036035 L = 4"
- 15 x6 036036 L = 90 mm
- 15 x6 036036 L = 3 1/2"
- 15a x6 036038 L = 75 mm
- 15a x6 036038 L = 3"
- 15b x6 036038 L = 75 mm
- 15b x6 036038 L = 3"
- 16 x6 036037 L = 60 mm
- 16 x6 036037 L = 2 1/2"
- 16b x6 036037 L = 60 mm
- 16b x6 036037 L = 2 1/2"
- 16a x6 036039 L = 50 mm
- 16a x6 036039 L = 2"
- 17 x6 036040 L = 40 mm
- 17 x6 036040 L = 1 1/2"
- 18a x6 036041 L = 25 mm
- 18a x6 036041 L = 1"
- 18b x6 036041 L = 25 mm
- 18b x6 036041 L = 1"

**S** Många modeller och delar bildar en unik och originell formgivning vilken är MECCANO S.A. engendom. Många av dessa modeller och delar är skyddade genom lagstiftning såsom industriell formgivning, varumärke och/eller upphovsmanrätt i ett flertal länder. Varumärket MECCANO är ett registrerat varumärke av MECCANO S.A. och kan ej användas utan tillstånd. För mer detaljerad information, var vänlig och kontakta MECCANO S.A. 95 bis, rue Bellevue - 92100 BOULOGNE BILLANCOURT - FRANCE. Tél.(1) 41.10.09.50 - Fax : (1) 41.10.09.55

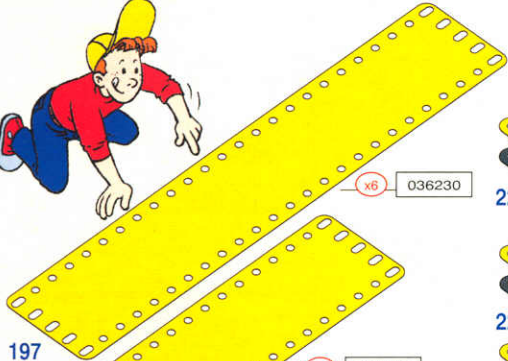

x6 036230

197



x6 036218

196



x6 036214

192



x6 036217

189



x6 036216

191



190a



x6 036246  
x6 036518

226



x6 036245  
x6 036517

225

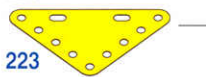

x6 036243

223



x3 036234  
x3 036514  
x3 036513

201

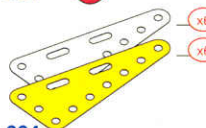

x6 036516  
x6 036244

224

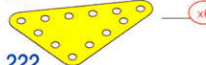

x6 036242

222



x3 036241  
x3 036515

221

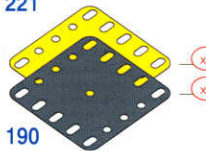

x6 036215  
x6 036511

190

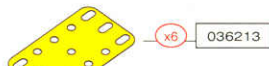

x6 036213

188

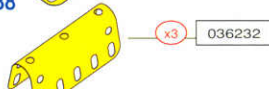

x3 036232

199

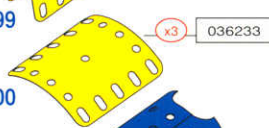

x3 036233

200

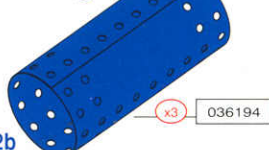

x3 036194

162b



x3 036240

216



x6 036195

163

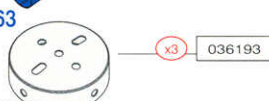

x3 036193

162a

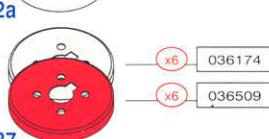

x6 036174  
x6 036509

137



x4 036280

187a



x3 036196

164

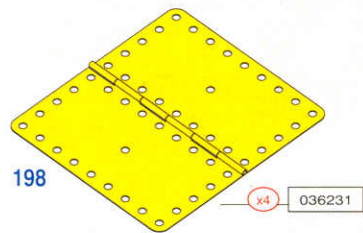

x4 036231

198

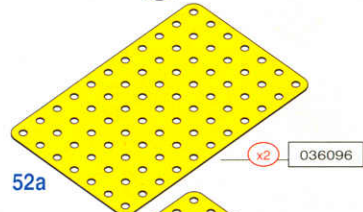

x2 036096

52a

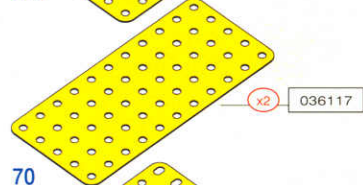

x2 036117

70

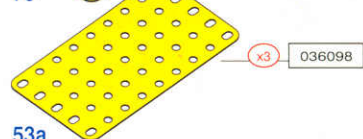

x3 036098

53a

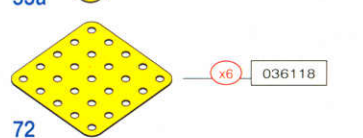

x6 036118

72

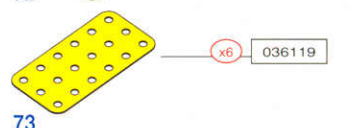

x6 036119

73



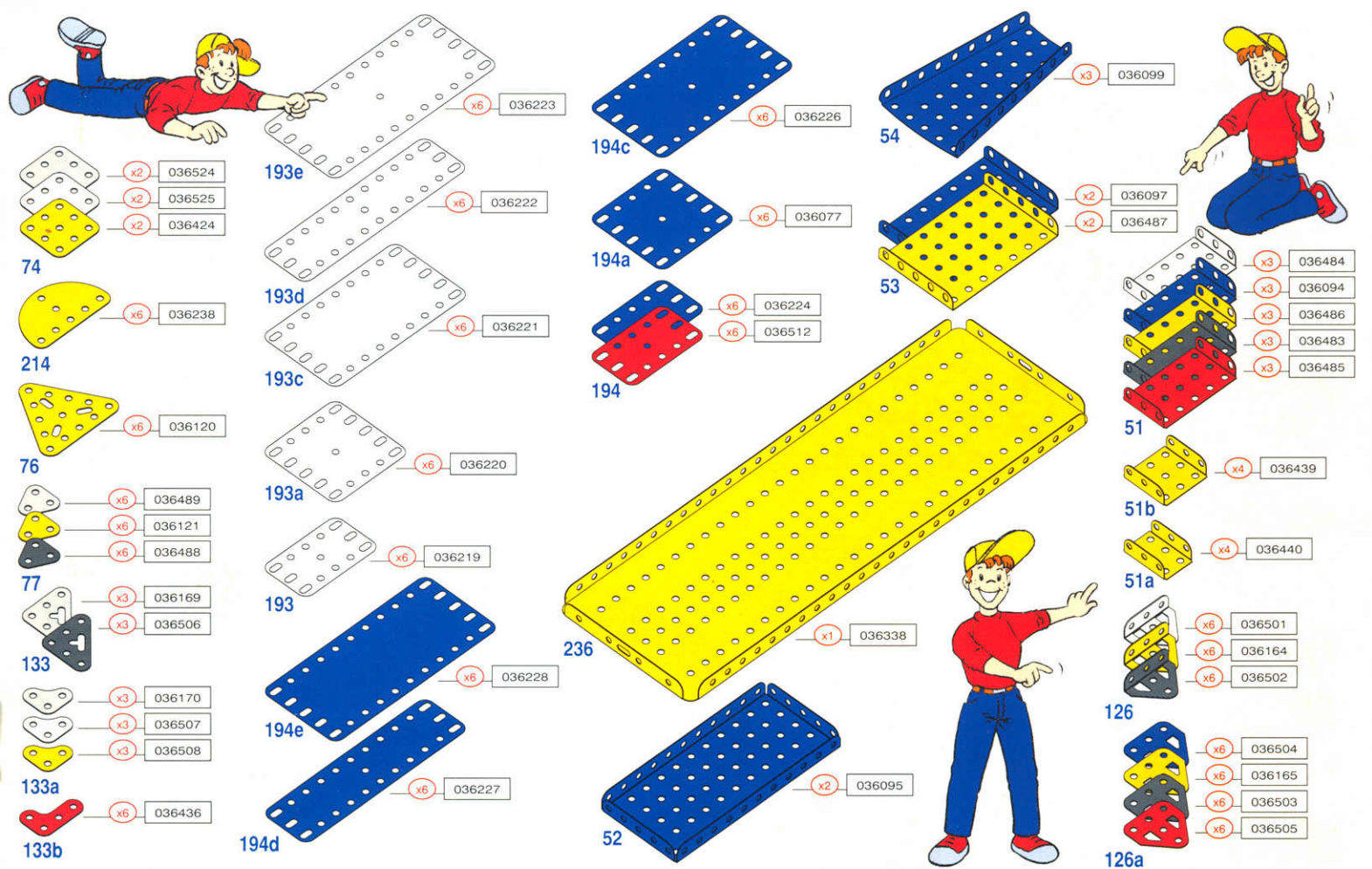

**(SF)** Useat mallit ja osat ovat MECCANO S.A.:n omaisuutta olevaa suunnittelua. Useat mallit ja osat ovat lailla suojattua teollista muotoilua, tavaramerkkiä ja/tai kopiontioikeuksia useissa maissa. Tuotemerkki MECCANO on MECCANO S.A.:n omaisuutta oleva rekisteröity tavaramerkki, jonka käyttö ilman lupaa on kielletty. Lisätietoja varten, ottakaa yhteyttä MECCANO S.A.:han MECCANO S.A. 95 bts, rue Bellevue - 92100 BOULOGNE BILLANCOURT - FRANCE Tél.(1) 41.10.09.50 - Fax : (1) 41.10.09.55

**(DK)** Mange modeller og komponentdele rummer unikt og originalt design, der er MECCANO S.A.'s ejendom. Mange af disse modeller og komponenter er beskyttet af lovgivning, såsom industrielt design, varemærker og/eller copyright i adskillige lande. Varemærket MECCANO er registreret varemærke tilhørende MECCANO S.A. og kan ikke anvendes uden tilladelse. For nærmere oplysninger, kontakt MECCANO S.A. MECCANO S.A. 95 bis, rue Bellevue - 92100 BOULOGNE BILLANCOURT - FRANCE Tél.(1) 41.10.09.50 - Fax : (1) 41.10.09.55

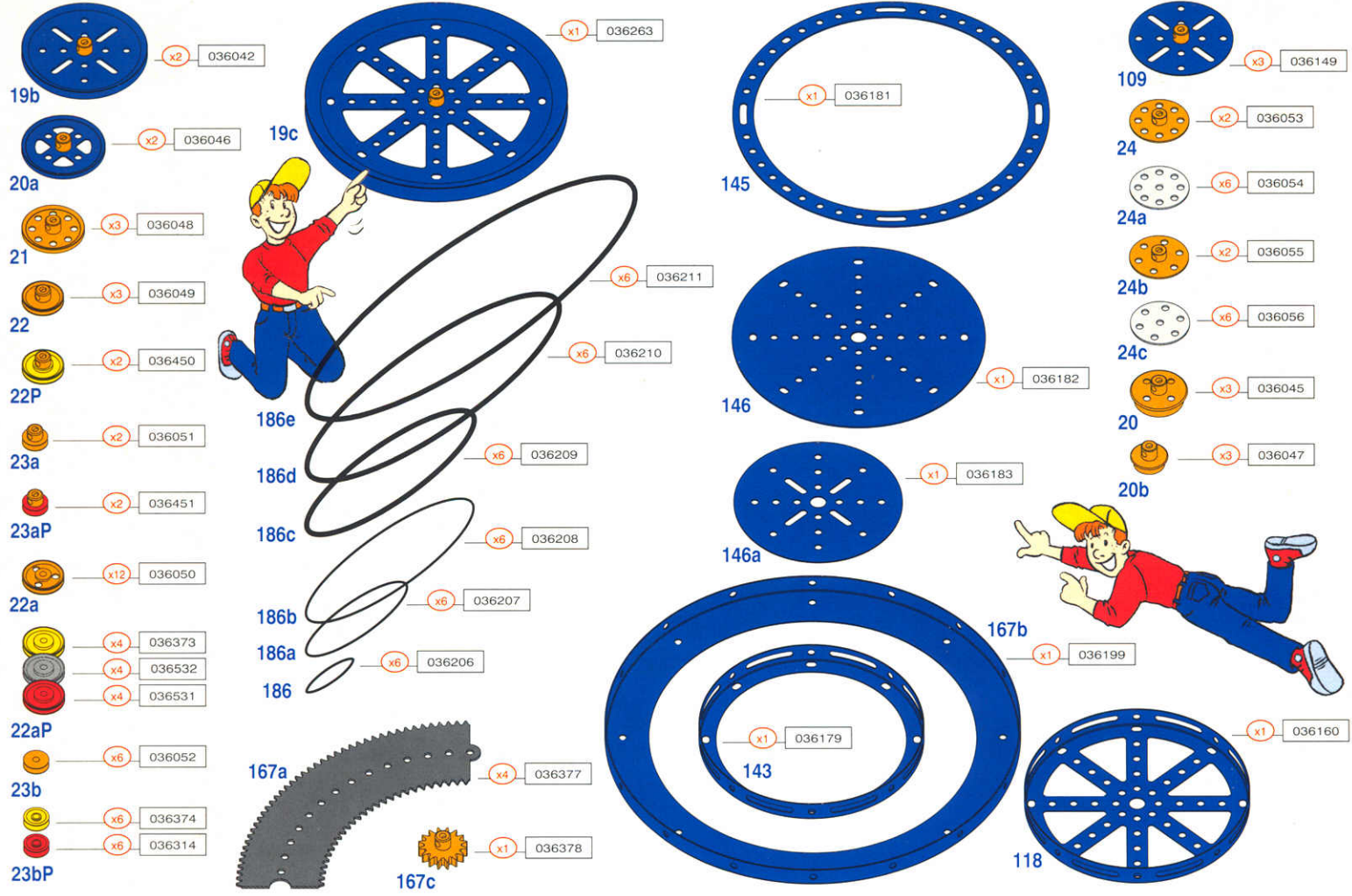



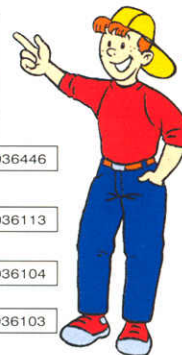
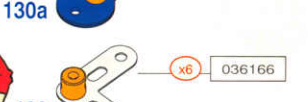
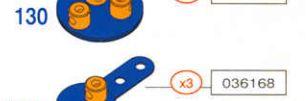
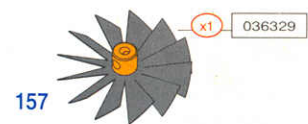
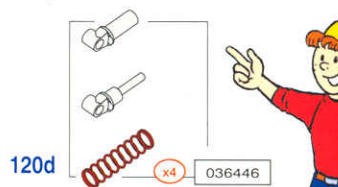
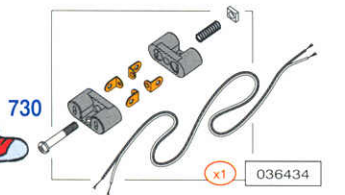
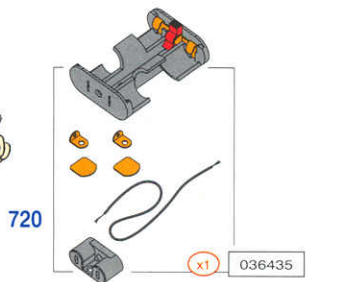
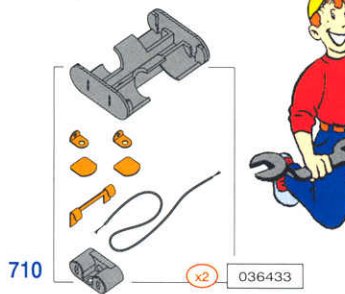
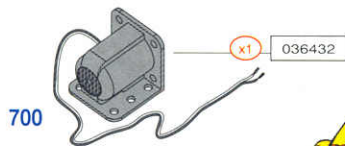
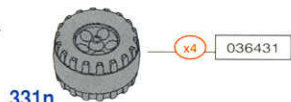
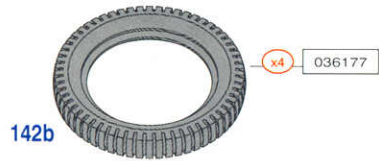



27c (x2) 036066 95 \* Ø 63,5 mm  
2 1/2"

27b (x2) 036065 133 \* Ø 90 mm  
3 7/16"

27cP (x2) 036316 95 \* Ø 63,5 mm  
2 1/2"



27 (x2) 036063 50 \* Ø 33,5 mm  
1 3/16"



27a (x2) 036064 57 \* Ø 38 mm  
1 1/2"

27d (x2) 036067 60 \* Ø 40 mm  
1 9/16"



27aP (x2) 036477 57 \* Ø 38 mm  
1 1/2"

27dP (x2) 036317 60 \* Ø 40 mm  
1 9/16"



28 (x1) 036069 50 \* Ø 38 mm  
1 1/2"

29 (x2) 036070 25 \* Ø 19 mm  
3/4"



28P (x1) 036528 50 \* Ø 38 mm  
1 1/2"



28P (x1) 036299 50 \* Ø 38 mm  
1 1/2"

30d (x1) 036072 30a 16 \* Ø 14,5 mm  
9/16"

30c 48 \* Ø 40 mm  
1 7/16"

30 (x2) 036071 26 \* Ø 23,5 mm  
1 5/16"

Teeth	Dents	Zähne	Dentelli
✪	Tänder	Taender	Hampaat
	Tanden	Dentes	Δόντια
			齒

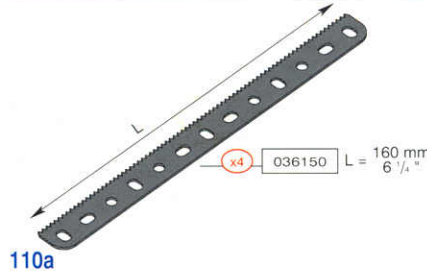

110a

(x4) 036150 L = 160 mm  
6 3/4"



25 (x2) 036057 25 \* Ø 19 mm L = 6 mm  
3/8"

25a (x3) 036058 25 \* Ø 19 mm L = 13 mm  
1/2"

26 (x2) 036059 19 \* Ø 13 mm L = 6 mm  
1/2"

26a (x3) 036060 19 \* Ø 13 mm L = 13 mm  
1/2"

26b (x3) 036061 19 \* Ø 13 mm L = 19 mm  
3/4"

26c (x3) 036062 15 \* Ø 11 mm L = 6 mm  
1/4"

31 (x2) 036073 38 \* Ø 25 mm L = 6 mm  
1"

26P (x2) 036545 19 \* Ø 13 mm L = 6 mm  
1/2"

26n (x2) 036448 11 \* Ø 8,7 mm L = 6 mm  
1/16"

27f (x3) 036068 14 \* Ø 25,4 mm  
1"

211b (x1) 036384

211a (x1) 036383

32 (x1) 036074

32P (x2) 036419

148 (x1) 036187

147a (x3) 036184

147c (x3) 036186

131 (x3) 036368

171 (x3) 036201















140 (x2) 036175

165 (x3) 036197

116 (x4) 036158



GR Πολλά από τα μοντέλα και τα εξαρτήματα είναι μοναδικά και πρωτότυπα σχέδια και αποτελούν ιδιοκτησία της MECCANO A.E. Πολλά από αυτά τα μοντέλα και τα εξαρτήματα προστατεύονται σε πολλές χώρες χωρίς να είναι εφευρέσεις, σύμφωνα με τον νόμο ως βιομηχανικά σχέδια, εμπορικά σήματα ή και πνευματική ιδιοκτησία. Το σήμα MECCANO αποτελεί κατοχυρωμένο εμπορικό σήμα της MECCANO A.E. και δεν μπορεί να χρησιμοποιηθεί χωρίς άδεια. Για περισσότερες πληροφορίες, επικοινωνήστε με τη MECCANO S.A.: Διεύθυνση...

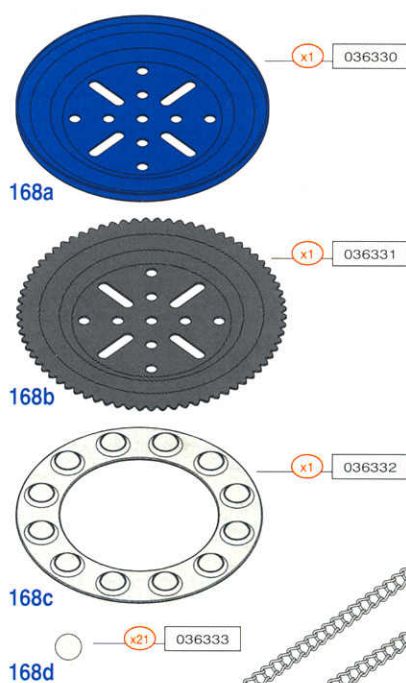

- 116a  x4 036159
- 166  x3 036198
- 63b  x3 036110
- 63  x3 036109
- 63c  x3 036111
- 63d  x2 036447
- 64  x3 036112
- 59  x4 036105
- 144  x1 036180
- 136  x6 036172
- 136a  x6 036173
- 50  x3 036093
- 179  x3 036204
- 173a  x3 036202

- 115a  x6 036388 L= 34 mm  $1\frac{3}{16}$ "
- 115  x6 036387 L= 15 mm  $\frac{9}{16}$ "
- 147g  x6 036429 L= 23 mm  $\frac{29}{32}$ "
- 147f  x6 036428 L= 19 mm  $\frac{3}{4}$ "
- 147d  x6 036427 L= 14,7 mm  $\frac{5}{16}$ "
- 147b  x12 036185 L= 14,7 mm  $\frac{5}{16}$ "
- 111d  x30 036544 L= 28 mm  $1\frac{1}{8}$ "
- 111  x30 036541 L= 19 mm  $\frac{3}{4}$ "
- 111a  x30 036542 L= 12 mm  $\frac{1}{2}$ "
- 111c  x30 036543 L= 9,5 mm  $\frac{3}{8}$ "
- 37ab  x50 036536 L= 5,8 mm  $\frac{1}{64}$ "
- 38  x50 036079
- 38a  x25 036420
- 38d  x12 036080  
x12 036478
- 23c  x12 036444
- 35  x12 036076
- 69a  x12 036115 L= 4 mm  $\frac{1}{32}$ "



- 213  x6 036237
- 213c  x6 036441

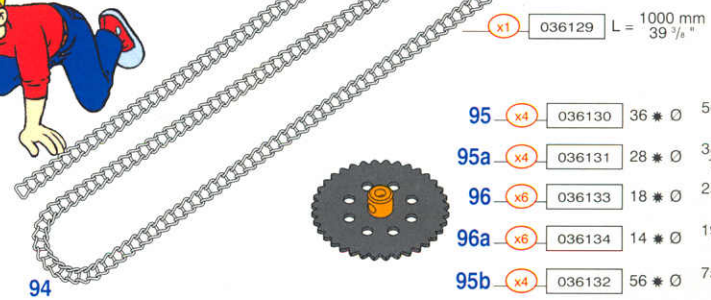

- 95  x4 036130 36 \*  $\varnothing$  50 mm  $2"$
- 95a  x4 036131 28 \*  $\varnothing$  38 mm  $1\frac{1}{2}"$
- 96  x6 036133 18 \*  $\varnothing$  25 mm  $1"$
- 96a  x6 036134 14 \*  $\varnothing$  19 mm  $\frac{3}{4}"$
- 95b  x4 036132 56 \*  $\varnothing$  75 mm  $3"$

C1



C2



C3



C4



C5



(GB) **Complementary sets :**  
Complementary set C2 make a Basic set 2 into a Basic set 3 and so on.

(F) **Boite de conversion :**  
Une boite de conversion C2, en complément d'un coffret Basic 2, permet d'obtenir le contenu donc les modèles du coffret Basic 3.

(D) **Ergänzungssets :**  
Das Ergänzungsset C2 erweitert das Basic Set 2 in den Standard des Basic Sets 3 usw.

(I) **Set complementari :**  
Un set complementare C2 permette di trasformare un set Basic 2 in un set Basic 3 e così via.

(S) **Kompletteringssetter :**  
Kompletteringssetter C2 gör ett Basic 2 till ett Basic 3 o.s.v.

(SF) **Täydennyssarjat :**  
Täydennyssarjan C2:n avulla Basic set 2:sta saa Basic set 3:n jne.

(DK) **Supplements-æske :**  
Som supplement til æsken Basic 2 - tilsammen giver de mulighed for at samle modellerne i æsken Basic 3.

(E) **Cajas Complementarias :**  
Uniendo la caja Complementaria C2 con la caja Básica N° 2, se obtiene la caja N° 3 y así sucesivamente.

(NL) **Aanvuldozen :**  
Aanvuldoos C2 maakt samen met basisdoos 2 : basisdoos 3 etc.

(P) **Caixas Complementares :**  
A caixa complementar C2 transforma a Básica N° 2 na Básica N° 3 e assim sucessivamente.

(GR) **Σετ μετατροπής :**  
Σε συνδυασμό με ένα σετ Basic 2, μπορεί το παιδί να αποκτήσει ότι χρειάζεται για την κατασκευή των μοντέλων του σετ Basic 3.

(JPN) **レベルアップボックス :**  
レベルアップボックスで、ベーシックキット2に新たな部品を追加し、ベーシックキット3と同じモデルが作れます。

Made in France by :  
Hecho en Francia :  
Fabriqué en France par :

Avenue de Saint Exupéry  
62100 CALAIS-FRANCE



x1 032231

MO

(GB) Motor set MO allows children to motorise their models.

(F) Coffret MO permettant de motoriser des modèles imaginés par l'enfant.

(D) Das Motor MO Set ermöglicht die Motorisierung des Modelle.

(I) Il set motore MO permette al bambino di motorizzare i modelli realizzati.

(S) Motorsats MO gör det möjligt för barnen att motorisera sina modeller.

(SF) Moottorisarja MO:n avulla rakentaja voi moottoroida mallinsa.

(DK) Med æsken MO kan man motorisere de modeller, barnet har samlet.

(E) El Motor MO permite al niño dar movimiento a sus modelos.

(NL) Met Motor Set MO kunnen Kinderen hun modellen van een motor voorzien.

(P) O Motor MO permite a criança motorizar os seus modelos.

(GR) Το σετ MO περιέχει τους μικρές κινητήρες που επιτρέπουν στο παιδί να δώσει κίνηση σε όποιο μοντέλο φανταστεί.

(JPN) モーターキットMOで、お子さんがイメージしたモデルがモーターで動くようになります。

M. W. MODELS  
4 Greys Road  
HENLEY - ON - THAMES  
Oxon. RG9 1RY  
ENGLAND